

A Multi-scale Model to Improve Anemia Treatment in Cancer Patients

Jens Timmer

Center for Systems Biology
Center for Data Analysis and Modeling
Department of Mathematics and Physics
University of Freiburg

Outline

- **Information processing of the Epo receptor**
- **Validating the model**
- **Epo and cancer**
- **Linking the cellular scale to the body scale**
- **Stratification of anemia patients**
- **Model-based personalized treatment**

Erythropoiesis

A Closed-Loop Control System

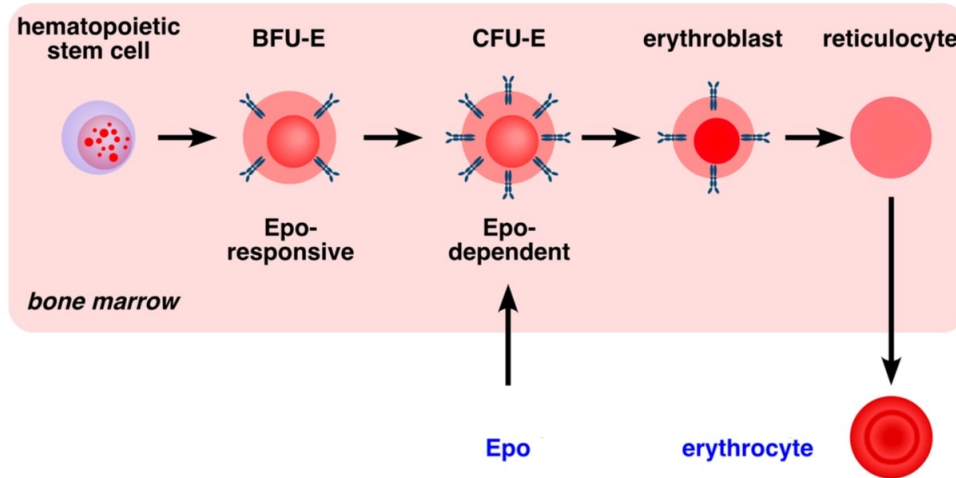

- **Epo**: key regulator of erythropoiesis

Erythropoiesis

A Closed-Loop Control System

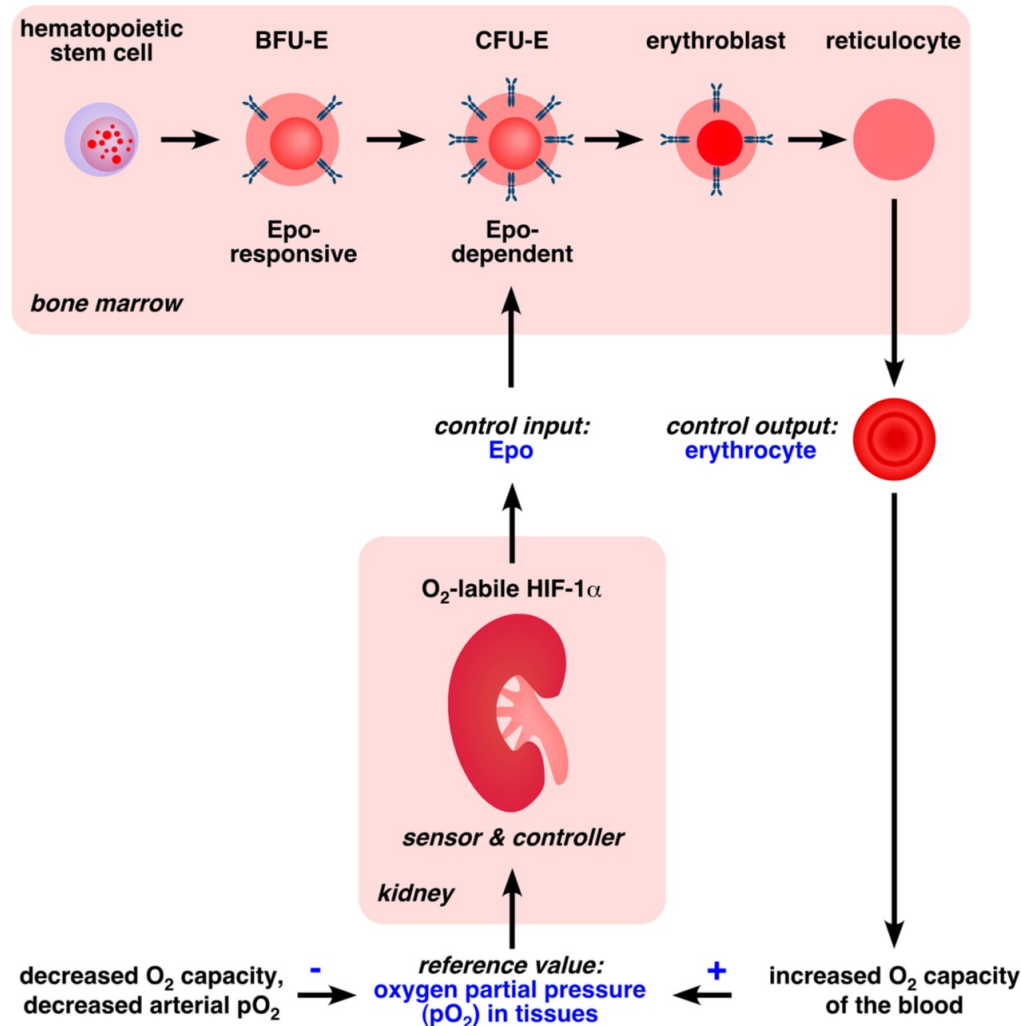

- **Epo:** key regulator of erythropoiesis
- **feedback via red blood cell mass:** establishing a closed-loop control circuit
- **normal conditions:** low levels of plasma Epo
15 mU/ml
- **hypoxic conditions:** increased Epo levels
up to 10000 mU/ml

Erythropoiesis

Coping with Different Ligand Concentrations

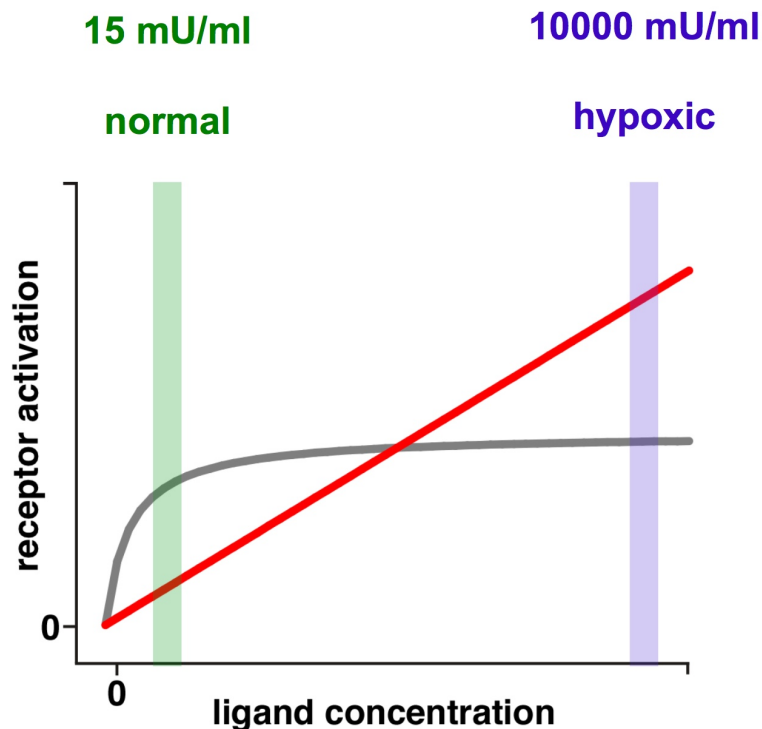

- How can large differences in Epo concentrations be processed by the EpoR?
- Which dynamic properties of the EpoR facilitate information processing over a broad ligand range?

Strategies for Processing Ligand-Encoded Information

abundance

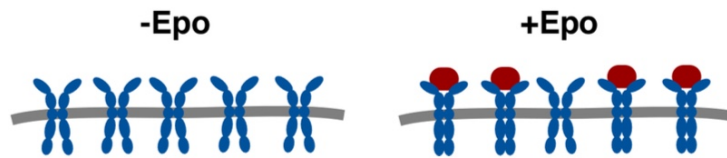

mobilization

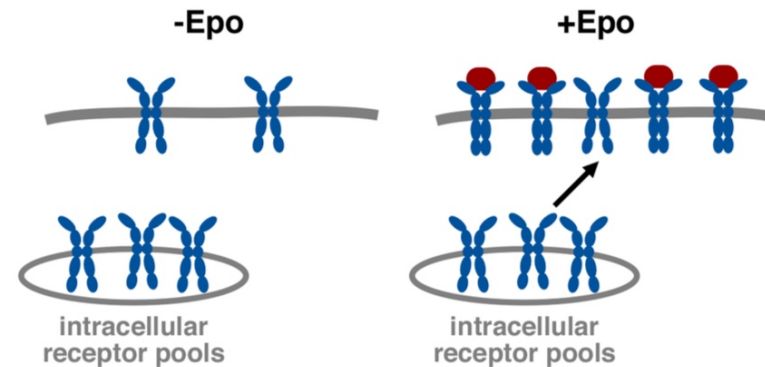

recycling

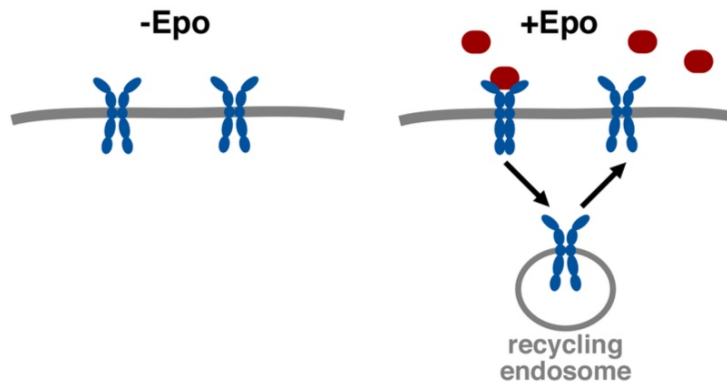

turnover

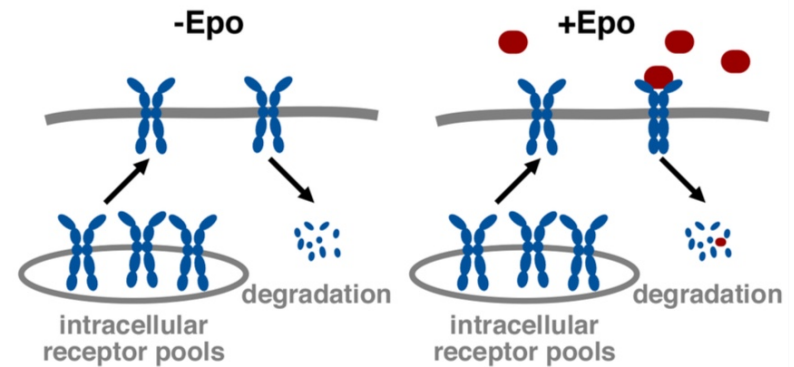

Strategies for Processing Ligand-Encoded Information

abundance

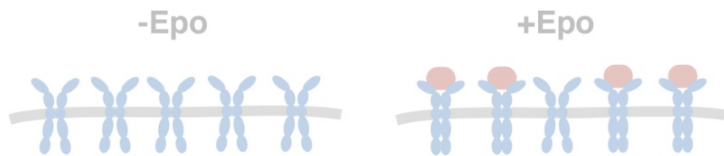

mobilization

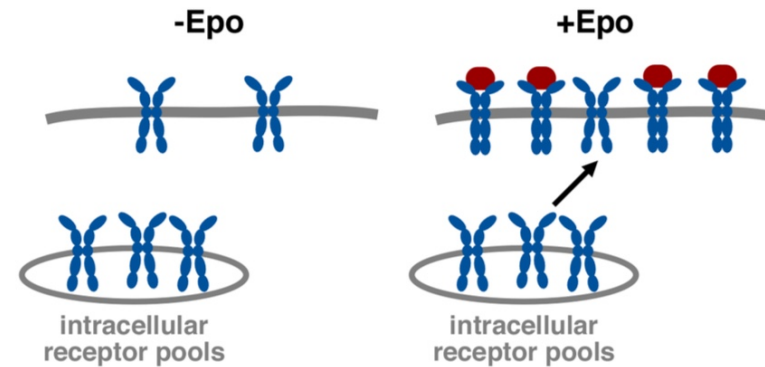

recycling

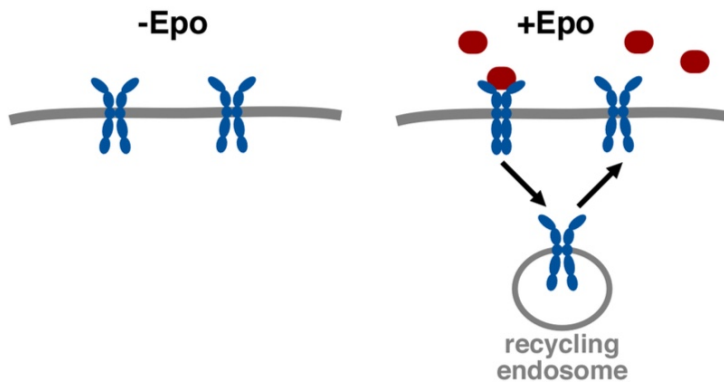

turnover

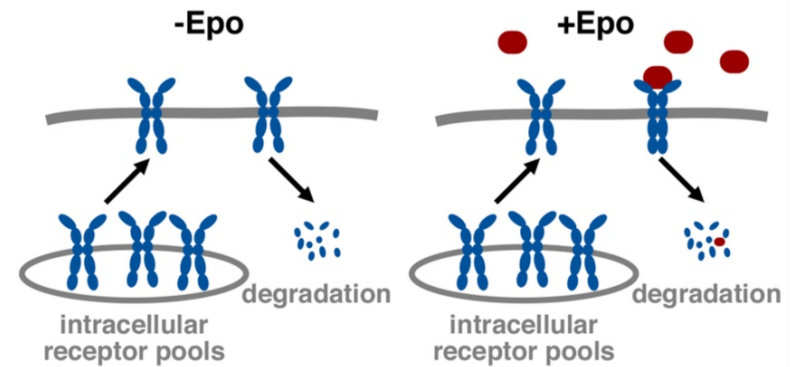

Mathematical Model for Epo-EpoR Interaction and Trafficking Kinetics

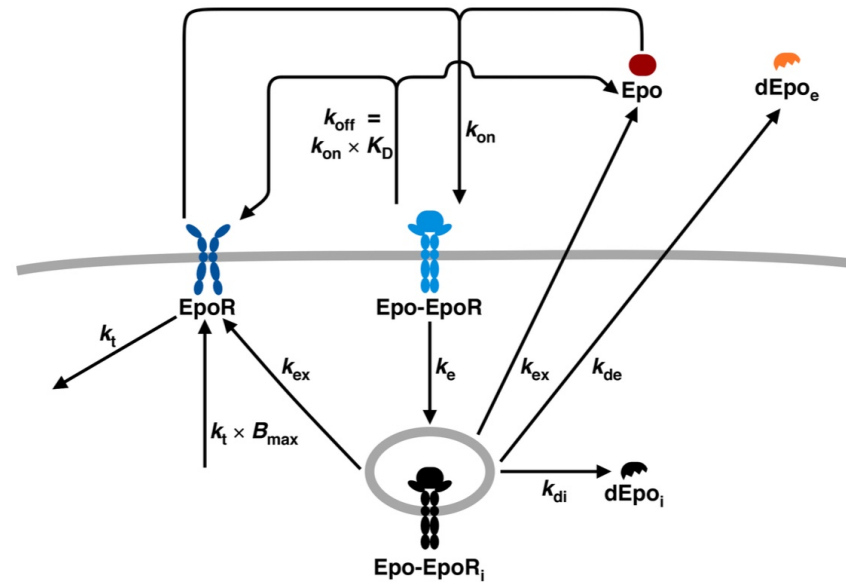

Mathematical Model for Epo-EpoR Interaction and Trafficking Kinetics

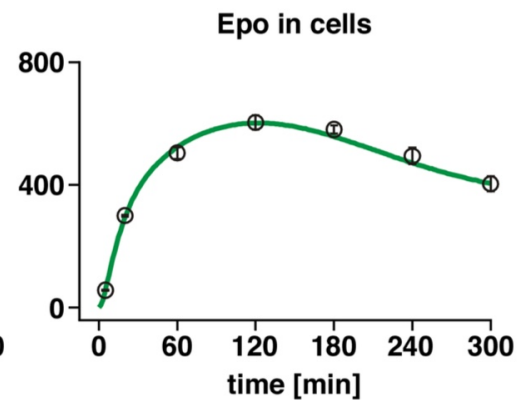
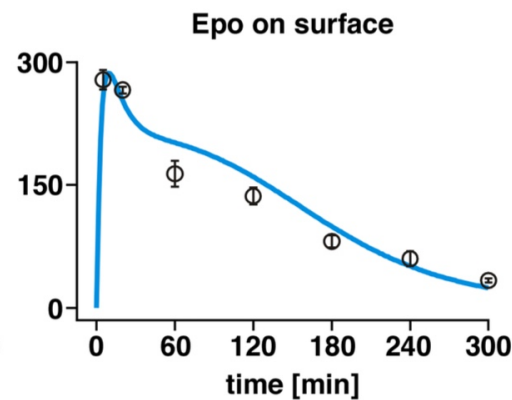
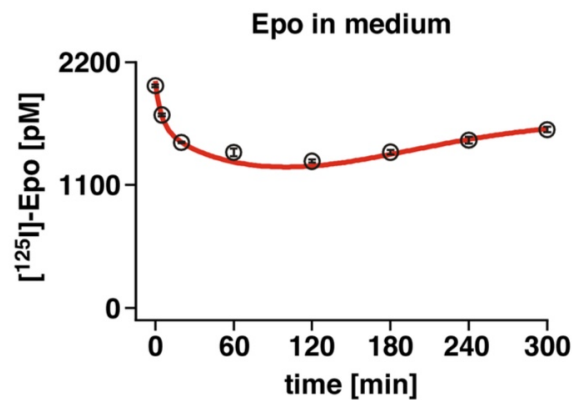
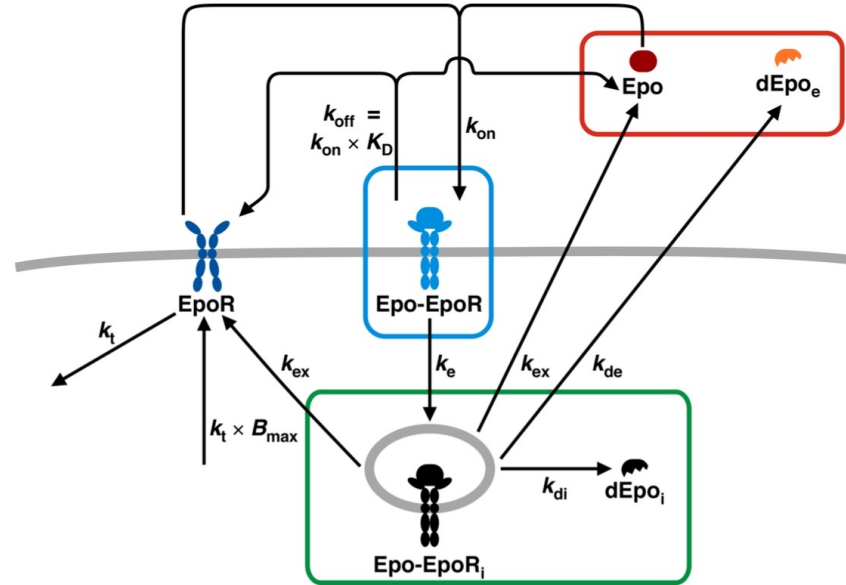

Identifiability Analysis: Profile Likelihood

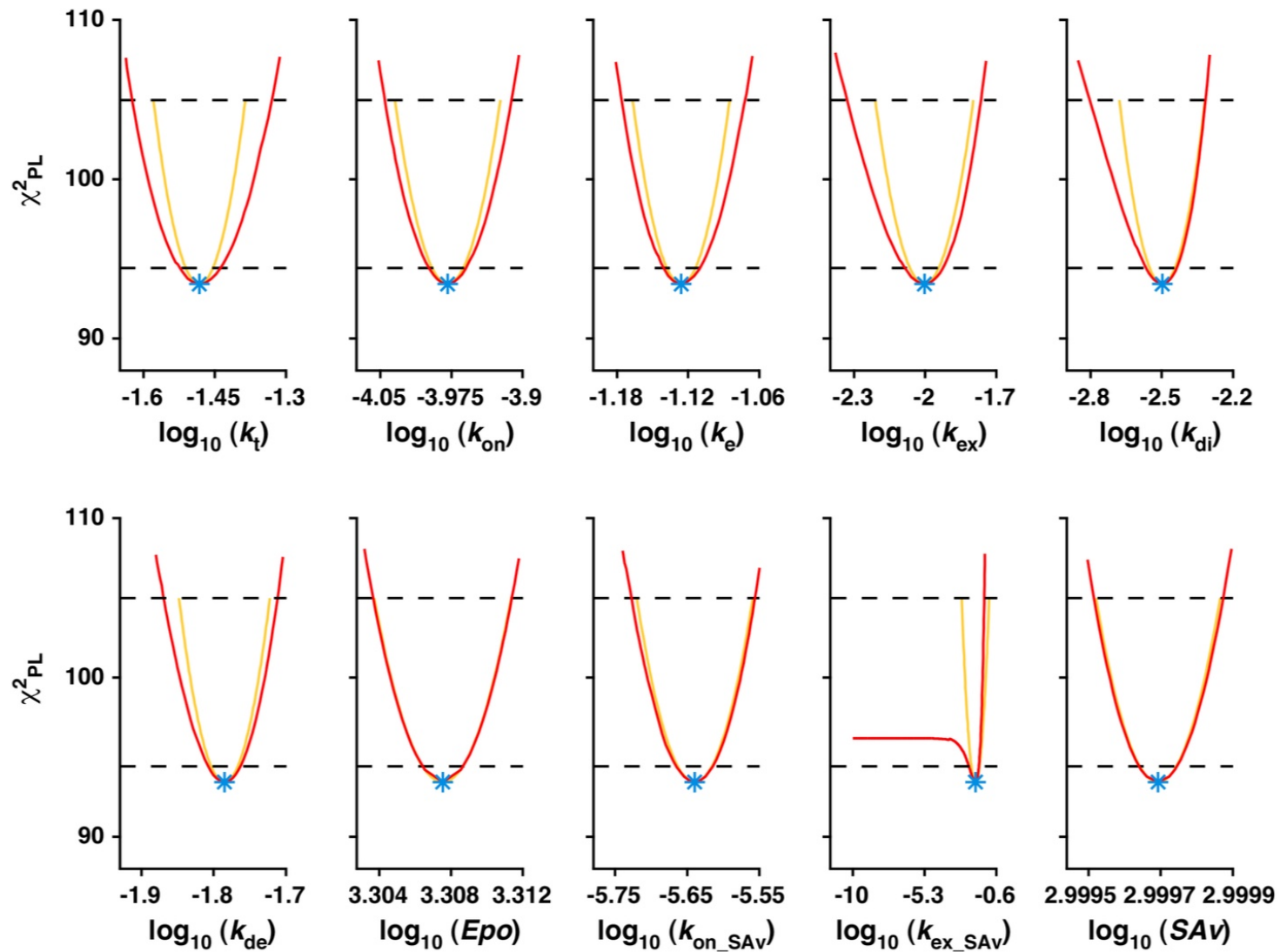

Analysis of Model Including EpoR Mobilization

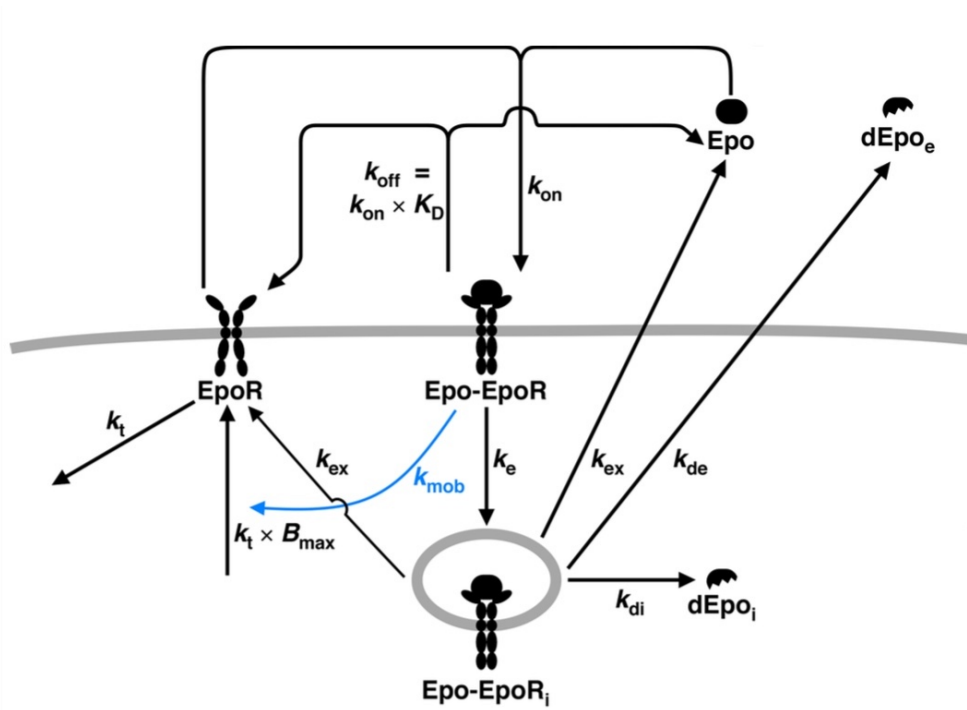

The Equations

'Core model' / 'Core model + k_{mob} '

Ordinary differential equations ('core model')

$$\begin{aligned} \text{EpoR} & \quad \dot{x}_1 = k_t \cdot B_{\max} - k_t \cdot x_1 - k_{on} \cdot x_1 \cdot x_2 + k_{off} \cdot x_3 + k_{ex} \cdot x_4 \\ \text{Epo} & \quad \dot{x}_2 = -k_{on} \cdot x_1 \cdot x_2 + k_{off} \cdot x_3 + k_{ex} \cdot x_4 \\ \text{Epo-EpoR} & \quad \dot{x}_3 = k_{on} \cdot x_1 \cdot x_2 - k_{off} \cdot x_3 - k_e \cdot x_3 \\ \text{Epo-EpoR}_i & \quad \dot{x}_4 = k_e \cdot x_3 - k_{ex} \cdot x_4 - k_{di} \cdot x_4 - k_{de} \cdot x_4 \\ \text{dEpo}_i & \quad \dot{x}_5 = k_{di} \cdot x_4 \\ \text{dEpo}_e & \quad \dot{x}_6 = k_{de} \cdot x_4 \end{aligned}$$

Ordinary differential equations ('core model + k_{mob} ')

$$\begin{aligned} \text{EpoR} & \quad \dot{x}_1 = k_t \cdot B_{\max} + k_{mob} \cdot x_3 - k_t \cdot x_1 - k_{on} \cdot x_1 \cdot x_2 + k_{off} \cdot x_3 + k_{ex} \cdot x_4 \\ \text{Epo} & \quad \dot{x}_2 = -k_{on} \cdot x_1 \cdot x_2 + k_{off} \cdot x_3 + k_{ex} \cdot x_4 \\ \text{Epo-EpoR} & \quad \dot{x}_3 = k_{on} \cdot x_1 \cdot x_2 - k_{off} \cdot x_3 - k_e \cdot x_3 \\ \text{Epo-EpoR}_i & \quad \dot{x}_4 = k_e \cdot x_3 - k_{ex} \cdot x_4 - k_{di} \cdot x_4 - k_{de} \cdot x_4 \\ \text{dEpo}_i & \quad \dot{x}_5 = k_{di} \cdot x_4 \\ \text{dEpo}_e & \quad \dot{x}_6 = k_{de} \cdot x_4 \end{aligned}$$

Assignment rules

$$k_{off} \quad k_{off} = k_{on} \cdot K_D$$

Nonzero initial values

$$\begin{aligned} \text{EpoR} & \quad x_1 = B_{\max} \quad (t=0) \\ \text{Epo} & \quad x_2 \quad (t=0) \end{aligned}$$

Observables

$$\begin{aligned} \text{Epo in medium} & \quad y_1 = x_2 + x_6 \quad (\text{Epo} + \text{dEpo}_e) \\ \text{Epo on surface} & \quad y_2 = x_3 \quad (\text{Epo-EpoR}) \\ \text{Epo in cells} & \quad y_3 = x_4 + x_5 \quad (\text{Epo-EpoR}_i + \text{dEpo}_i) \end{aligned}$$

Parameters

k_t	ligand-independent EpoR endocytosis
k_{mob}	ligand-induced EpoR mobilization
k_{on}	association of Epo and EpoR
k_{off}	dissociation of Epo and EpoR
K_D	dissociation constant for Epo-EpoR
k_e	ligand-induced EpoR endocytosis
k_{ex}	recycling of Epo and EpoR
k_{di}	degradation of ligand-EpoR complexes, remaining intracellular
k_{de}	degradation of ligand-EpoR complexes, secreted extracellular

Analysis of Model Including EpoR Mobilization

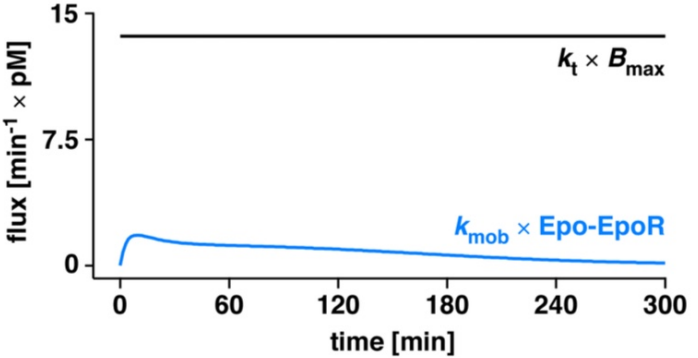
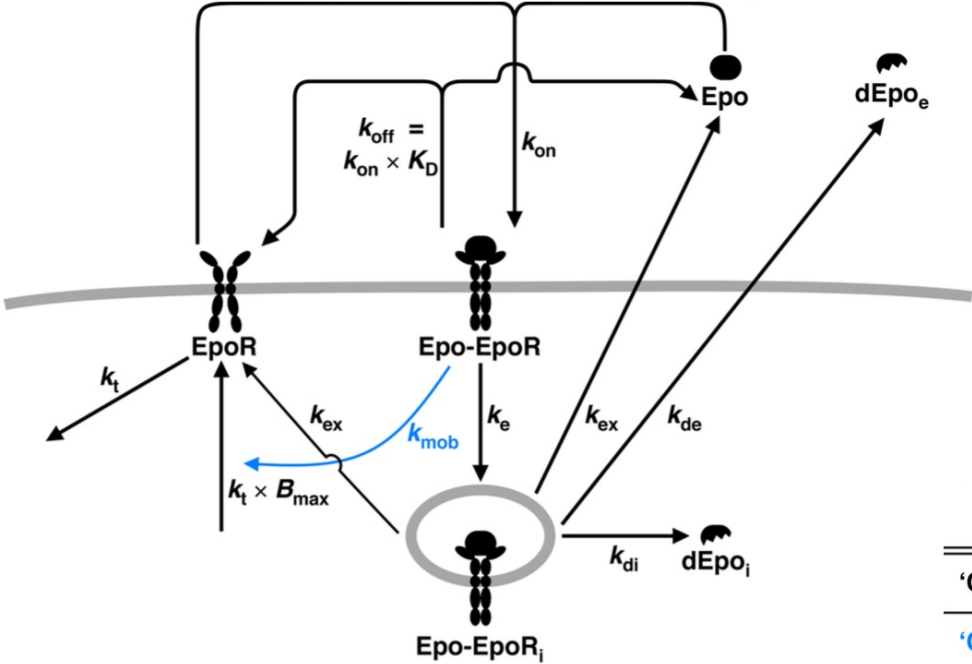

	# of parameters	$p(\text{LRT})$	AIC	BIC
'Core model'	10		172.2	186.9
'Core model + k_{mob} '	11	0.4178	173.6	189.7

Strategies for Processing Ligand-Encoded Information

abundance

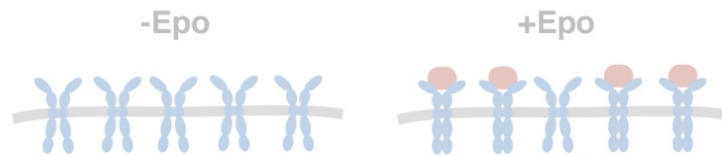

mobilization

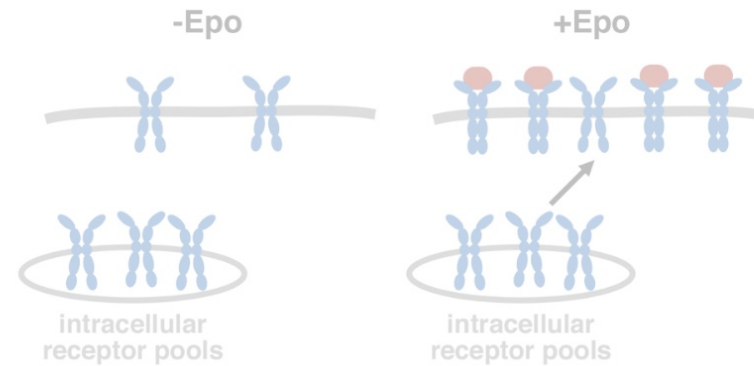

recycling

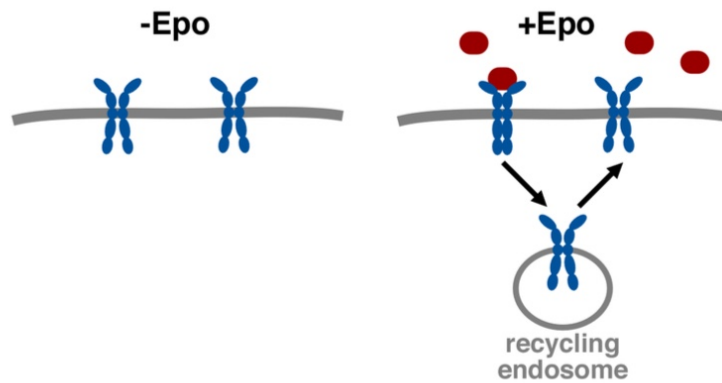

turnover

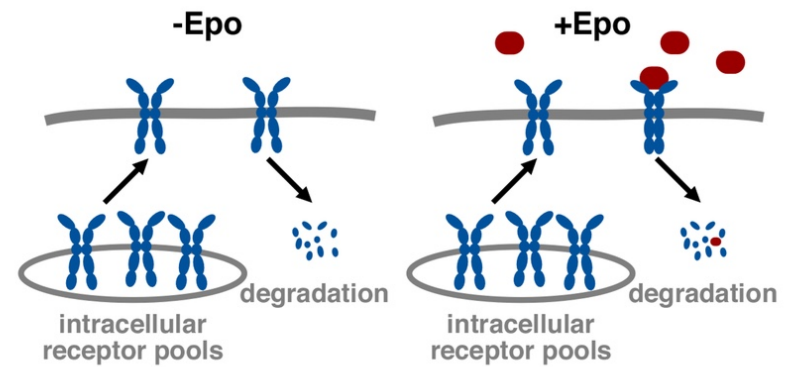

Key Properties of the EpoR System

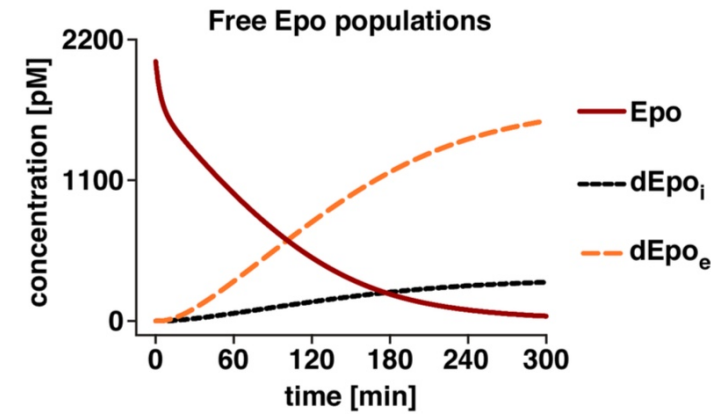
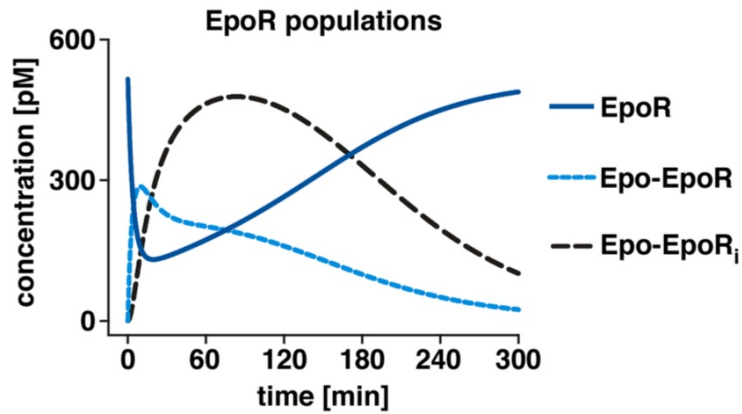
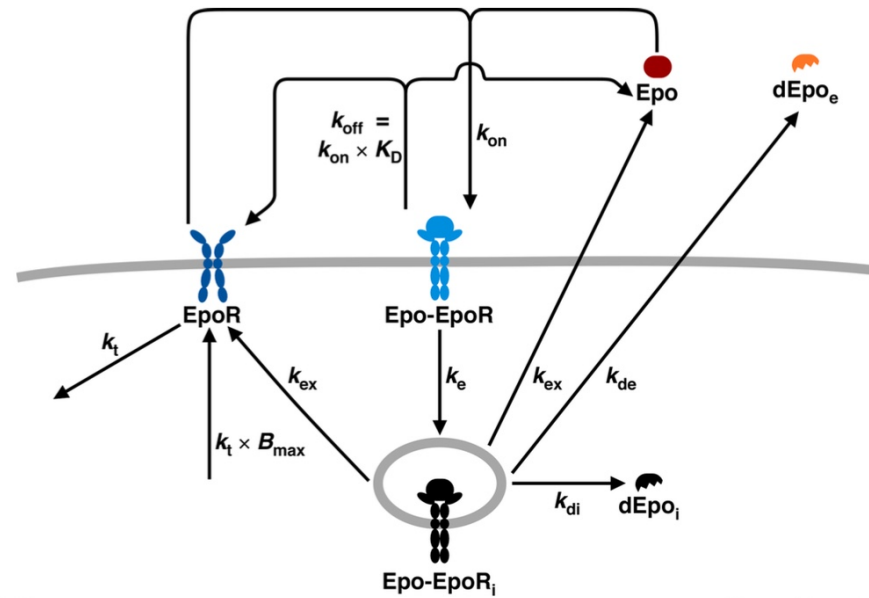

Rapid EpoR Recovery at the Cell Surface Model Prediction

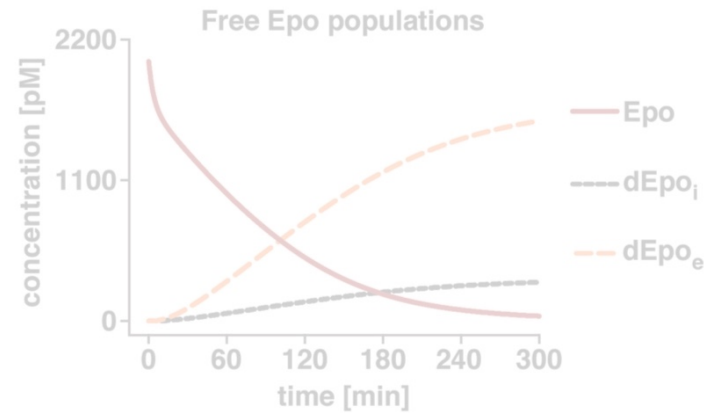
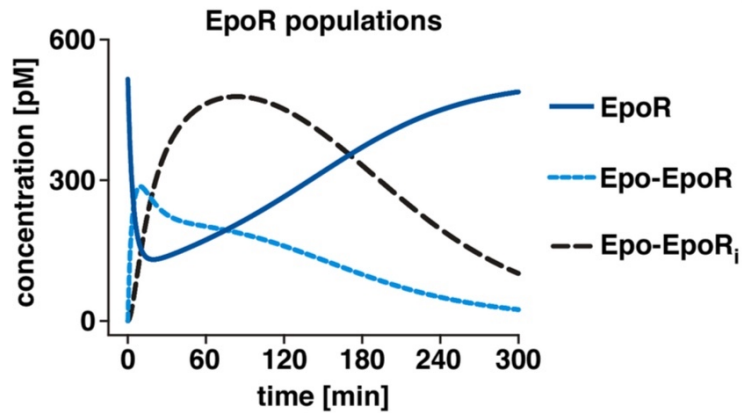
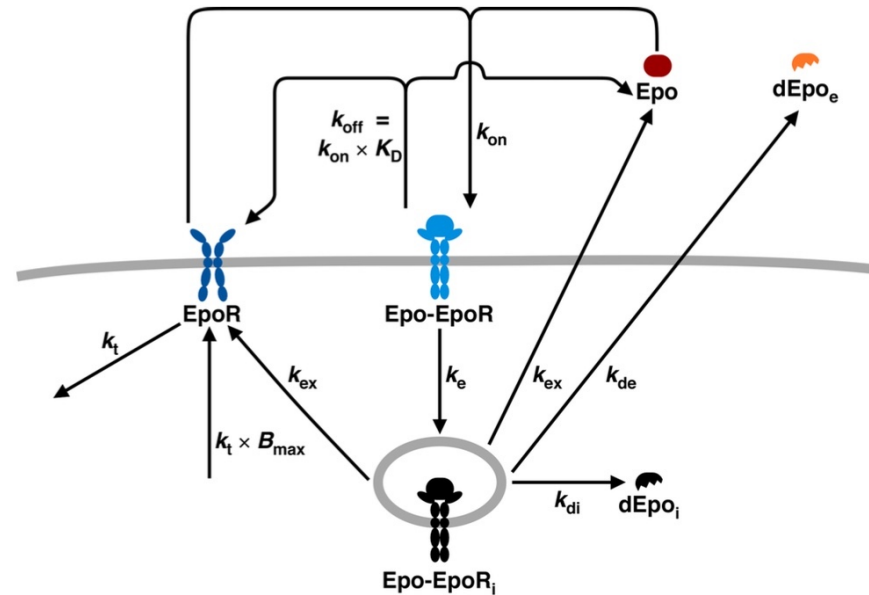

Rapid EpoR Recovery at the Cell Surface Model Validation

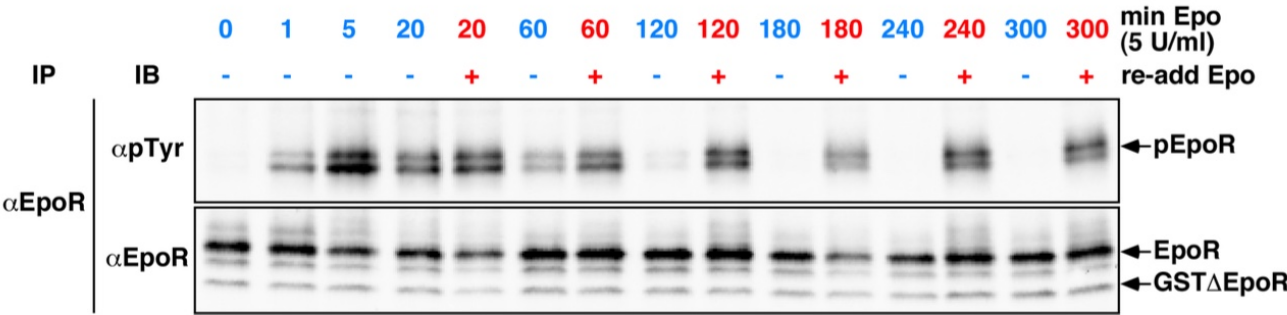
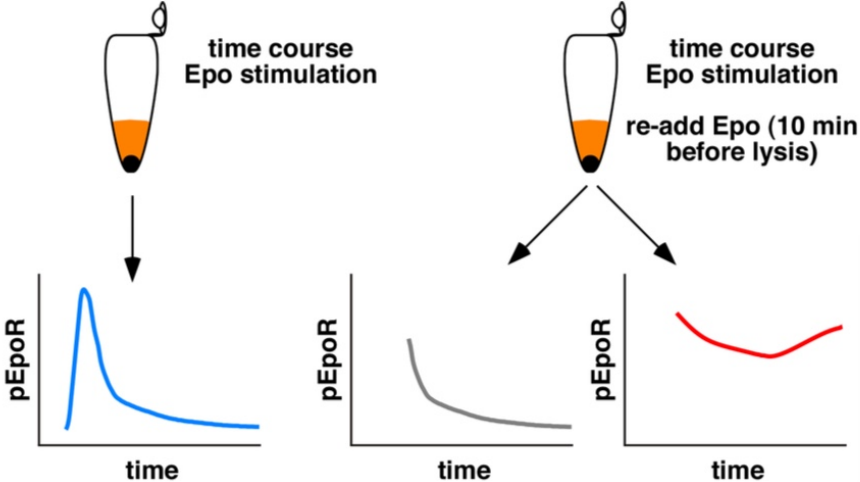

Rapid Epo Depletion - Model Prediction

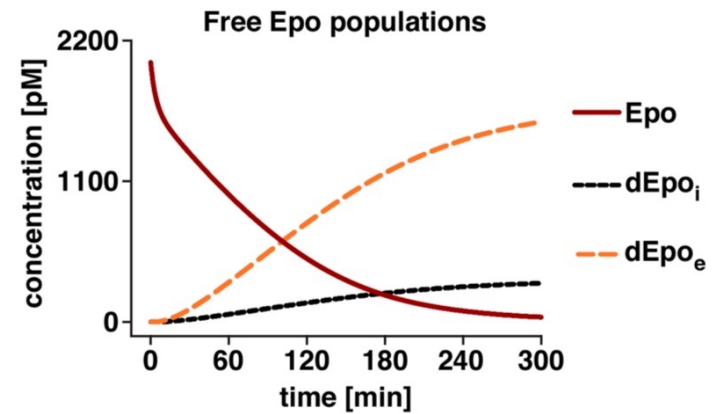
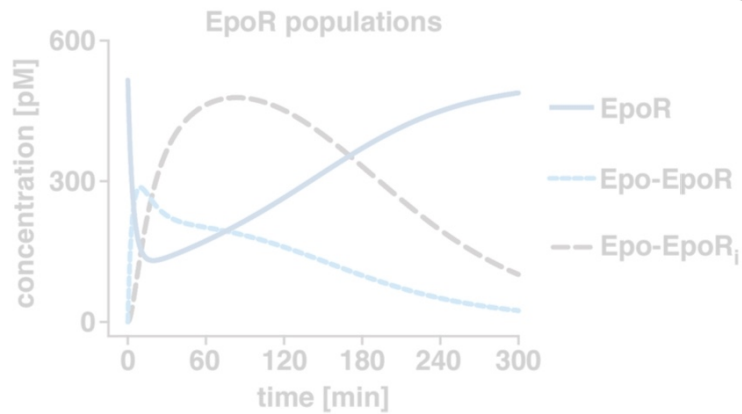
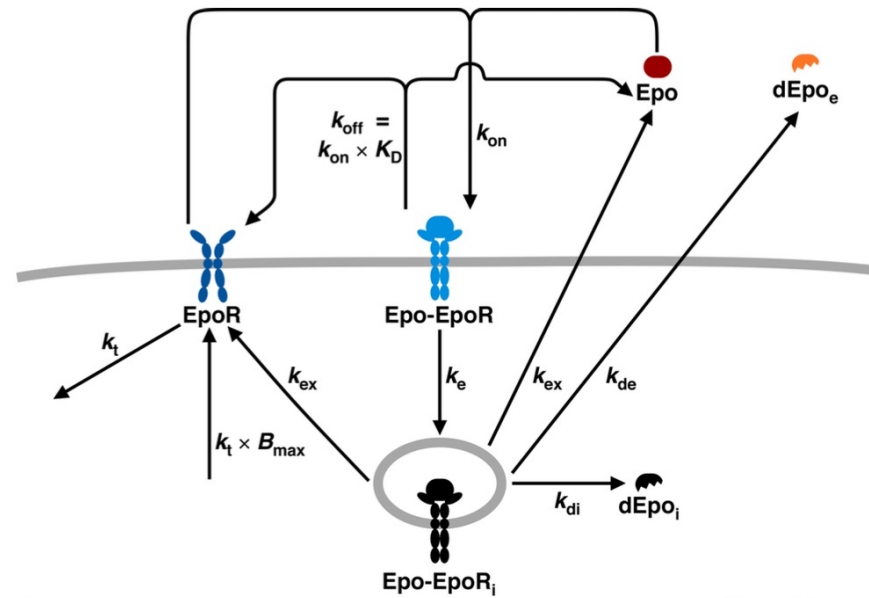

Rapid Epo Depletion - Model Validation

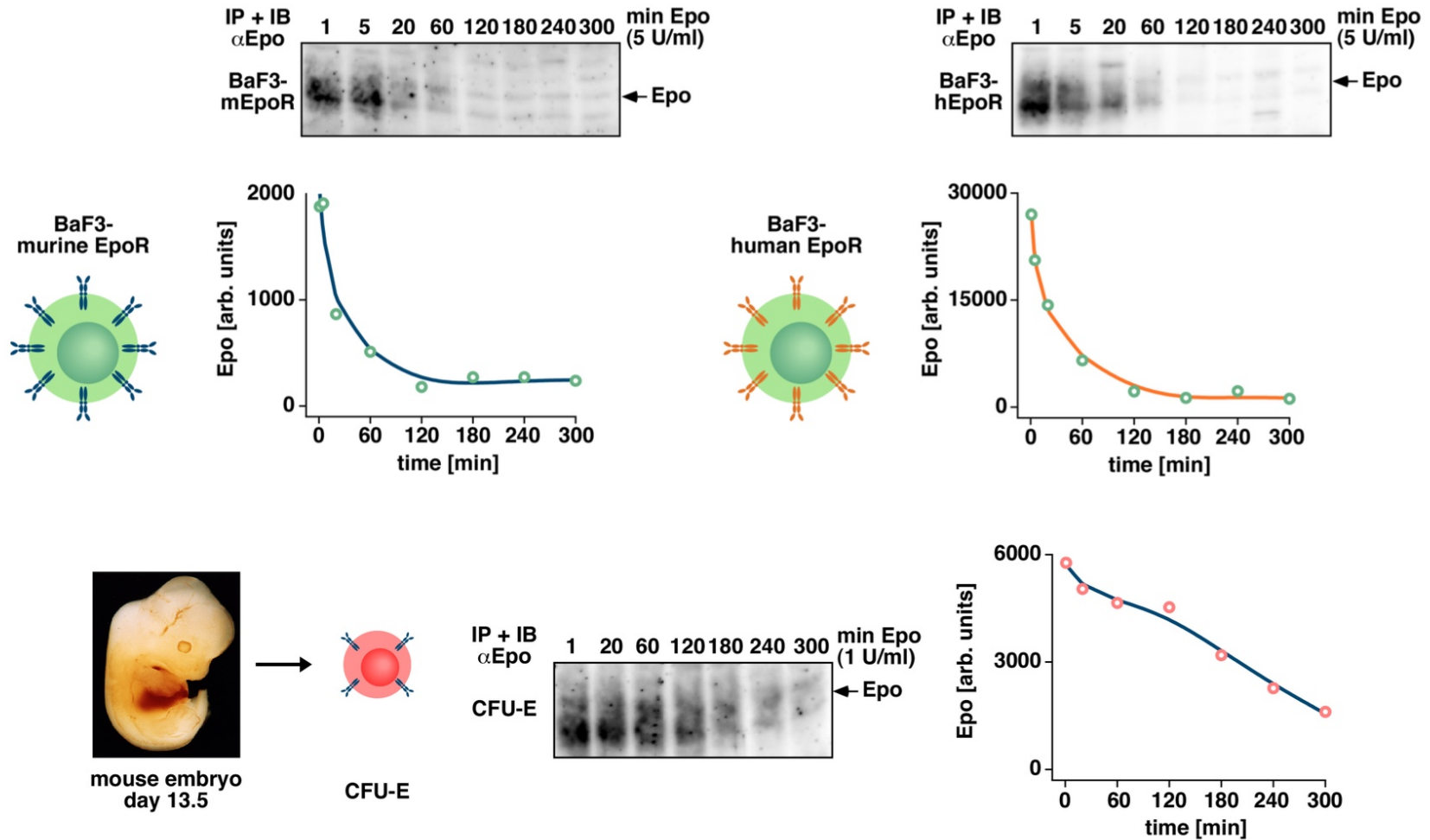

Strategies for Processing Ligand-Encoded Information

abundance

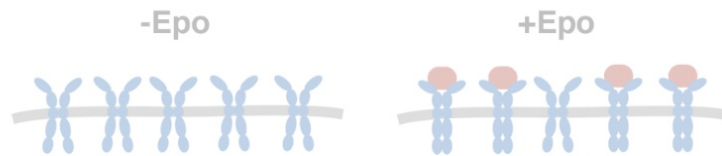

mobilization

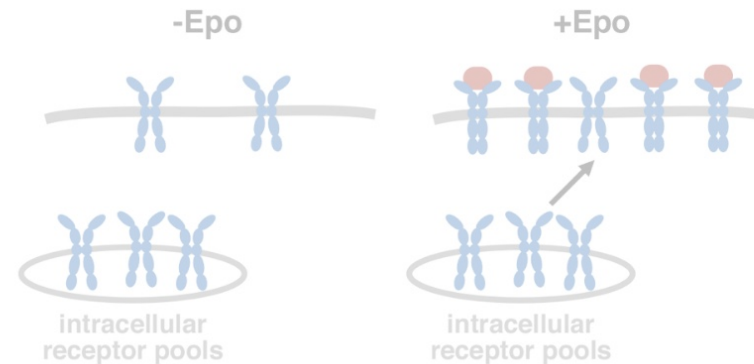

recycling

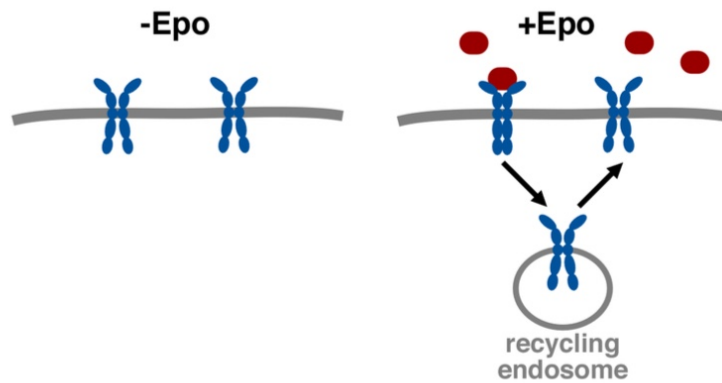

turnover

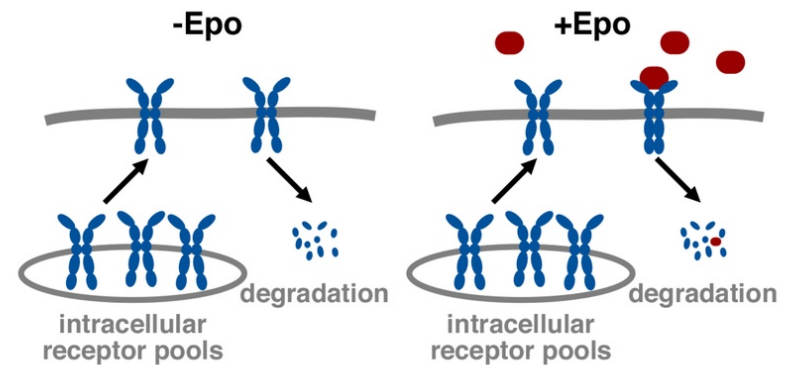

Linear EpoR Signaling for a Broad Range of Epo Levels

model simulations

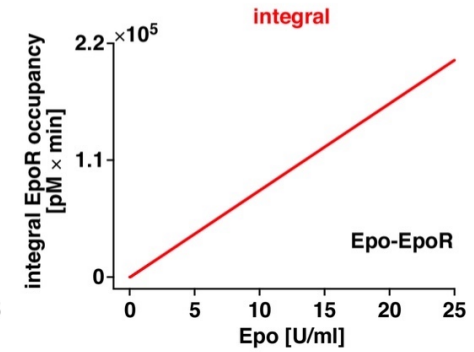
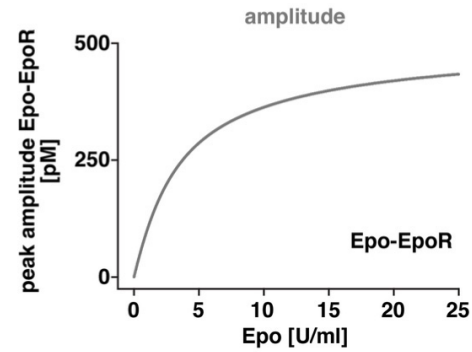
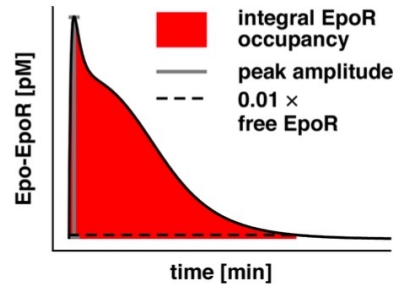

Linear EpoR Signaling for a Broad Range of Epo Levels

model simulations

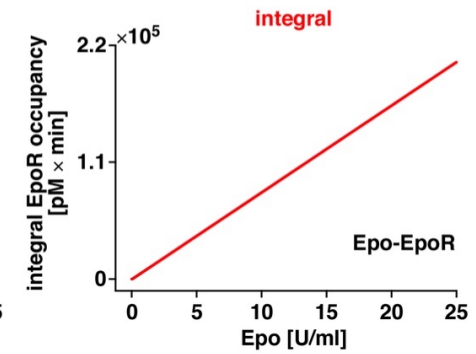
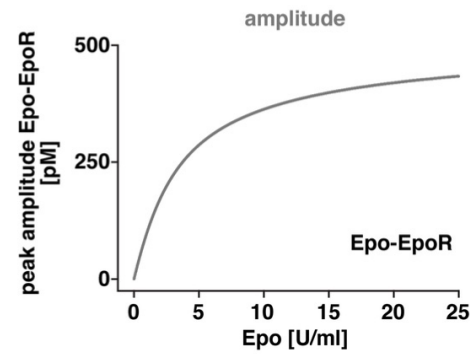
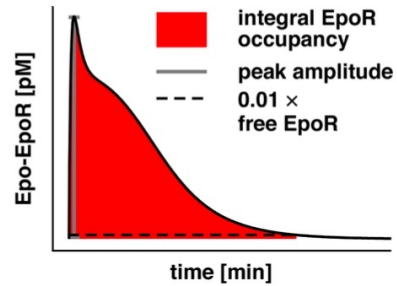

experiments

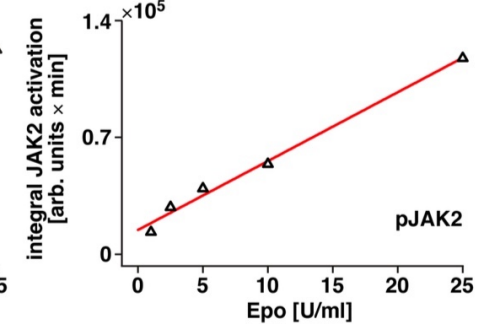
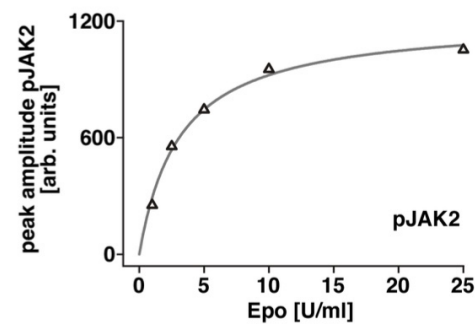
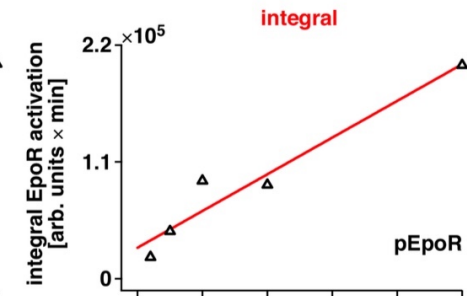
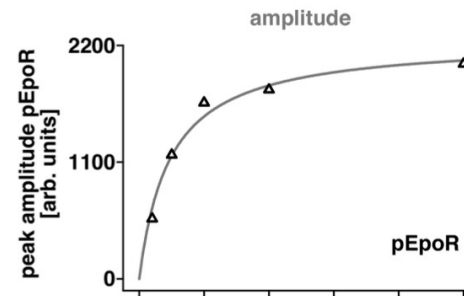
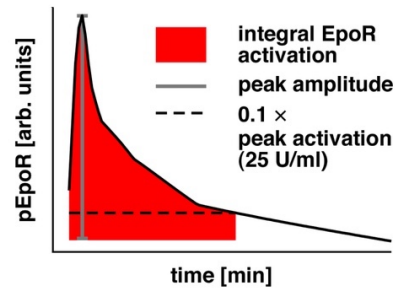

Dependency of Linear Relation

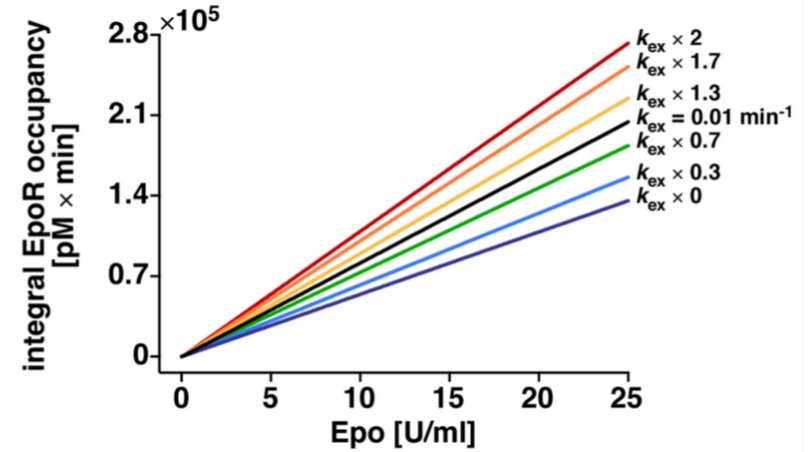
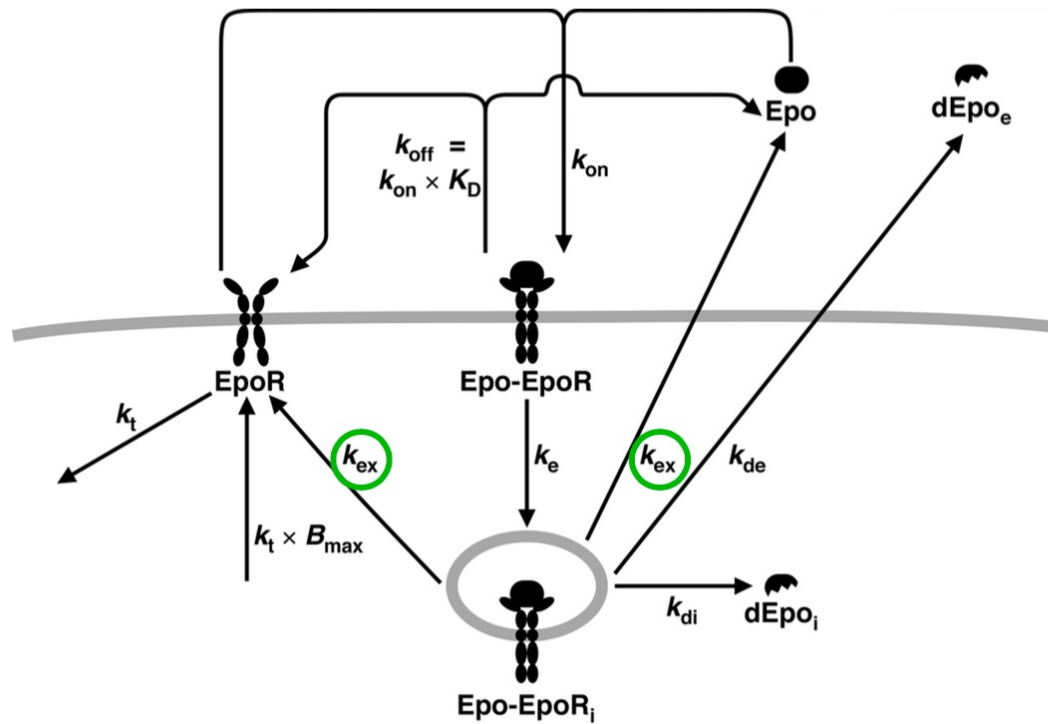

Dependency of Linear Relation on EpoR Turnover

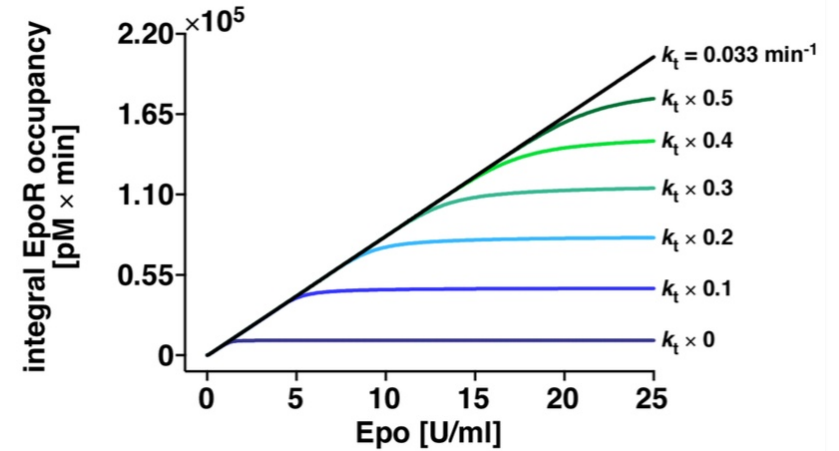
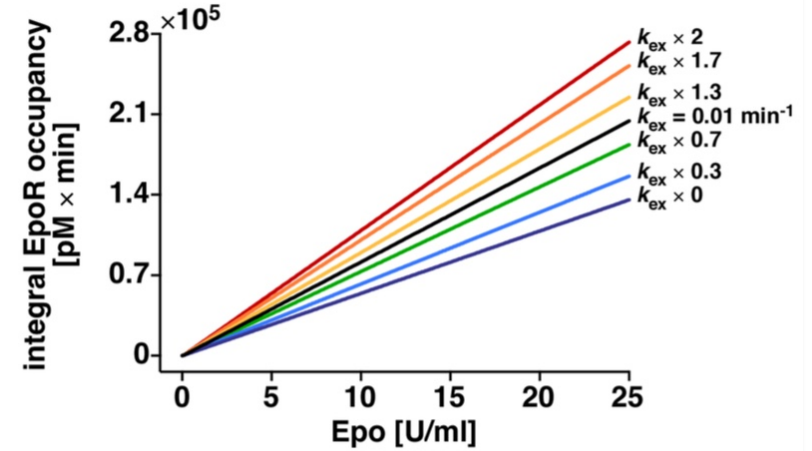
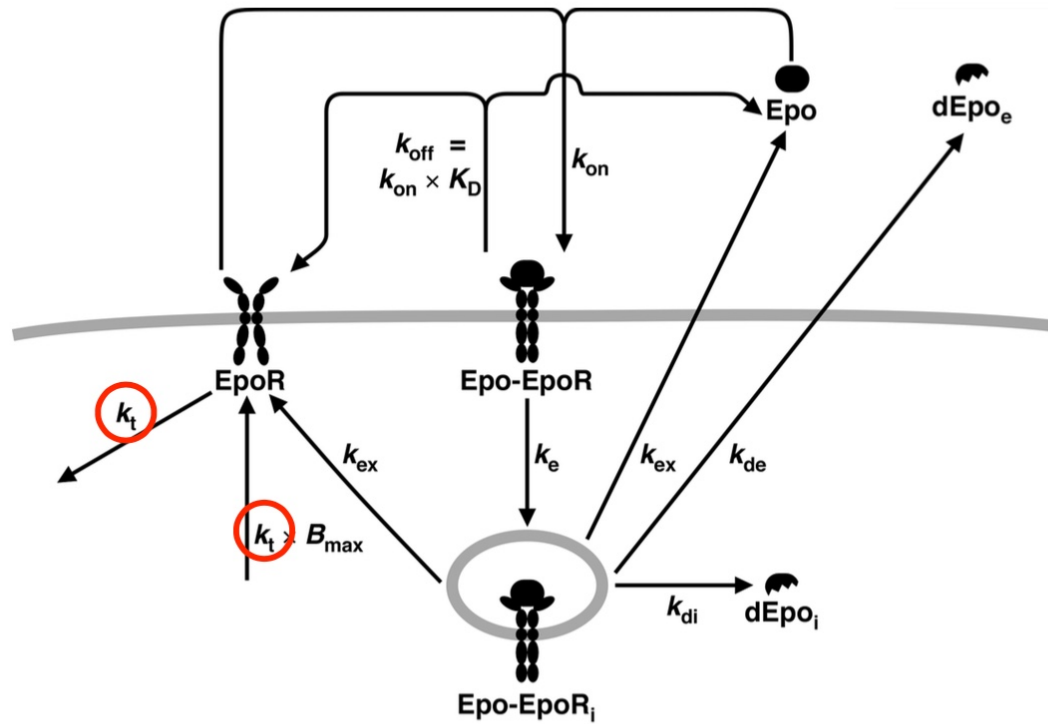

Contribution of Intracellular EpoR Pools

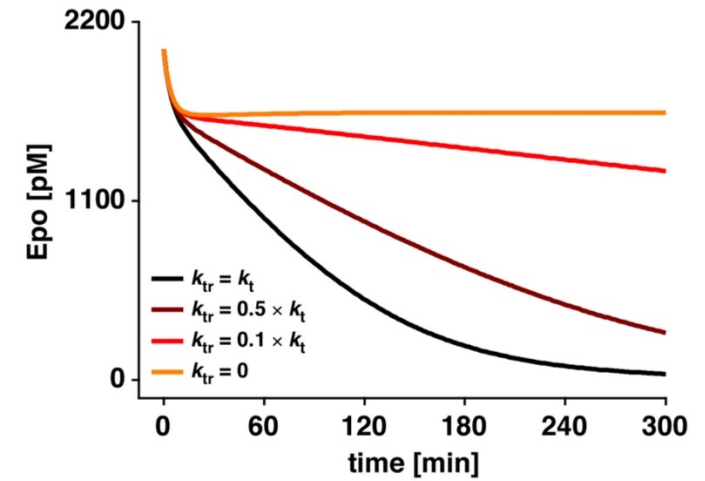
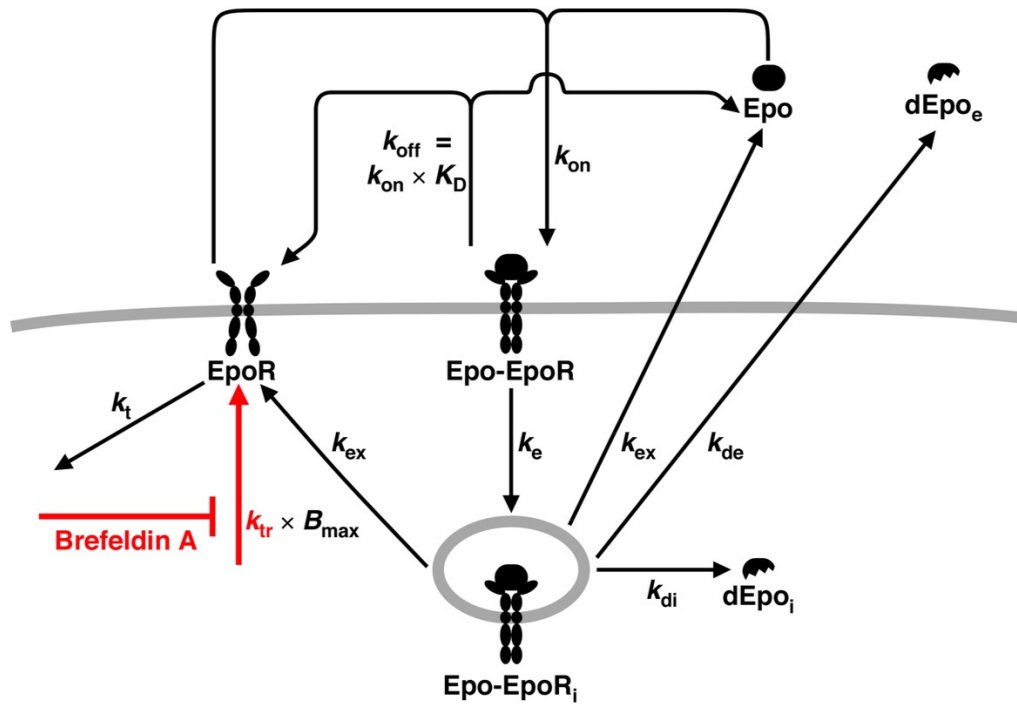

Contribution of Intracellular EpoR Pools

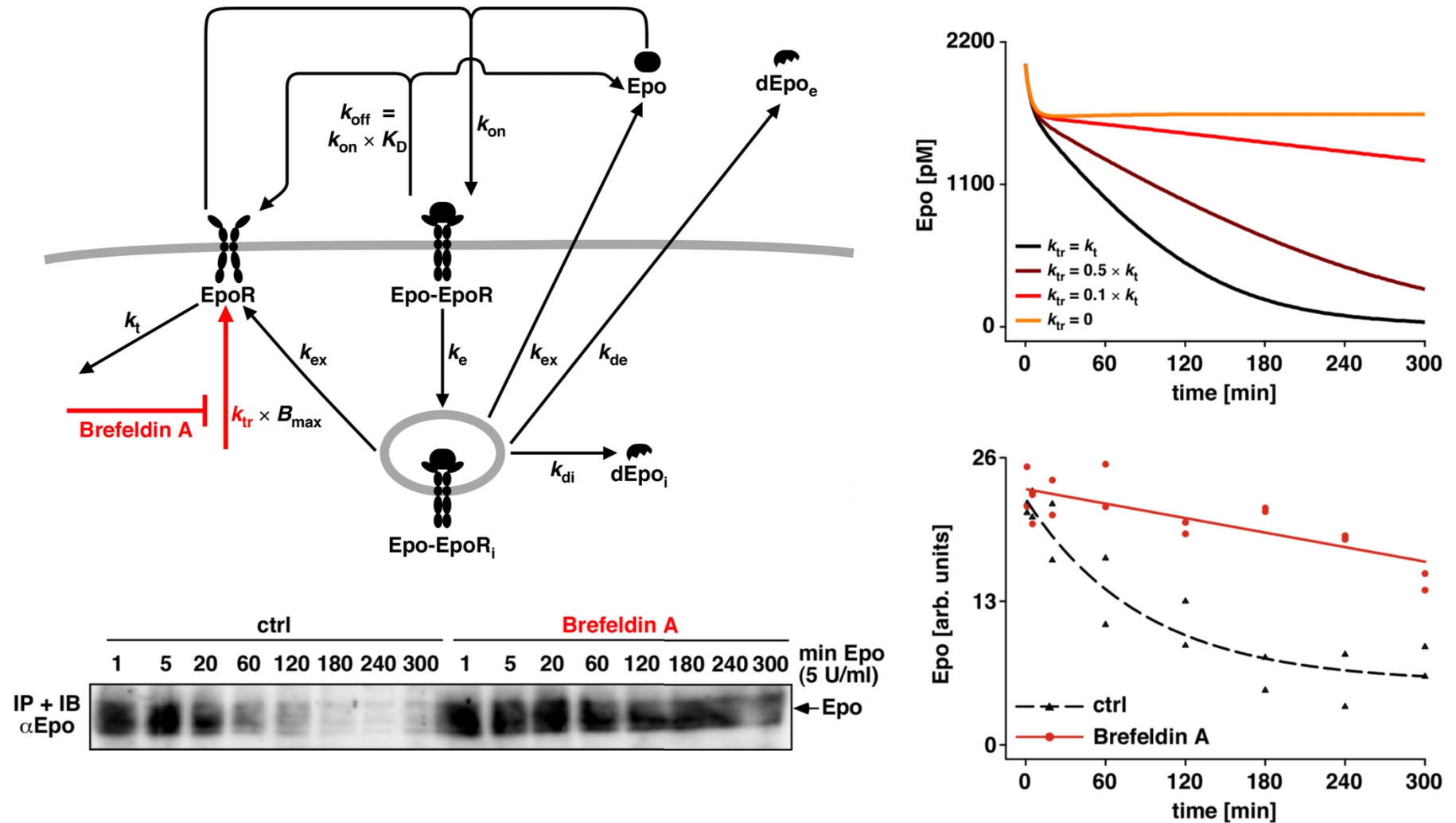

Becker et al. (2010) Covering a broad dynamic range: information processing at the erythropoietin receptor. Science 328 1404-1408

Epo and Cancer

- **As drug, not Epo is applied but genetically modified Epo**
- **ESA: Erythropoiesis Stimulation Agents**
- **Chemotherapy damages blood building system**
- **ESAs often applied during chemotherapy to fight anemia**
- **But, Epo-receptors also expressed on tumor cells**
- **Risk of overdosing, leading to cardio-vascular events**
- **Goal: Determine minimal effective dosing scheme**

Epo counteracts Chemotherapy

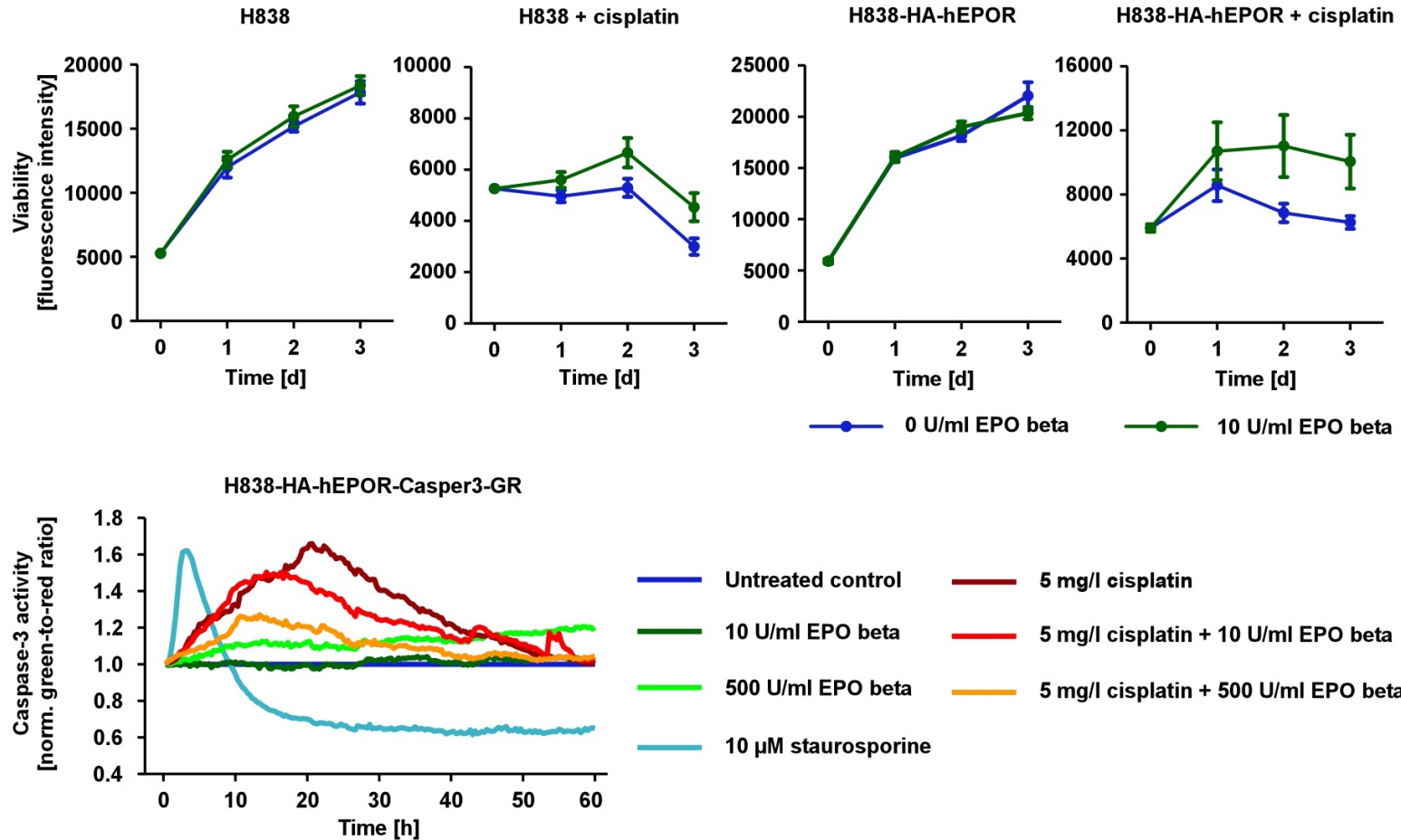

Merkle et al (2016). Identification of cell type-specific differences in erythropoietin receptor signaling in primary erythroid and lung cancer cells. PLoS Computational Biology 12, 1-34

Looking Downstream

Combine receptor model with STAT5 signaling model

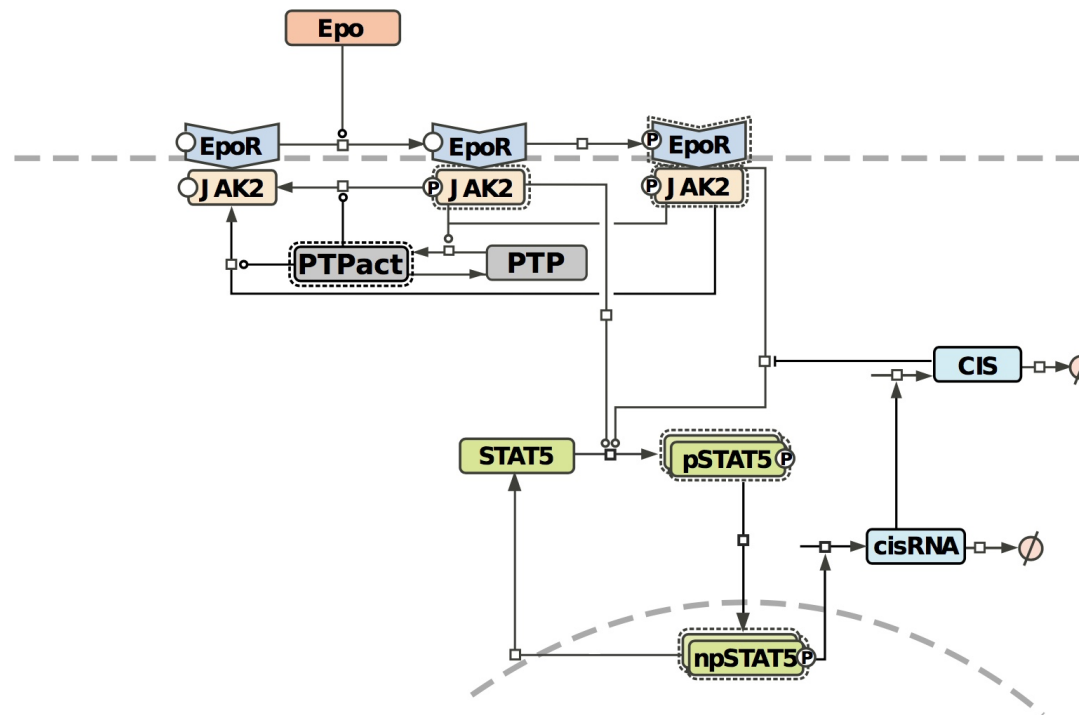

Bachmann et al. (2011) Division of labor by dual feedback regulators controls JAK2/STAT5 signaling over broad ligand range
Molecular Systems Biology 7, 1-15

Epo and Cancer

Question: Is there a difference in dosing effects ?

Integral nuclear pSTAT5 determines cell survival

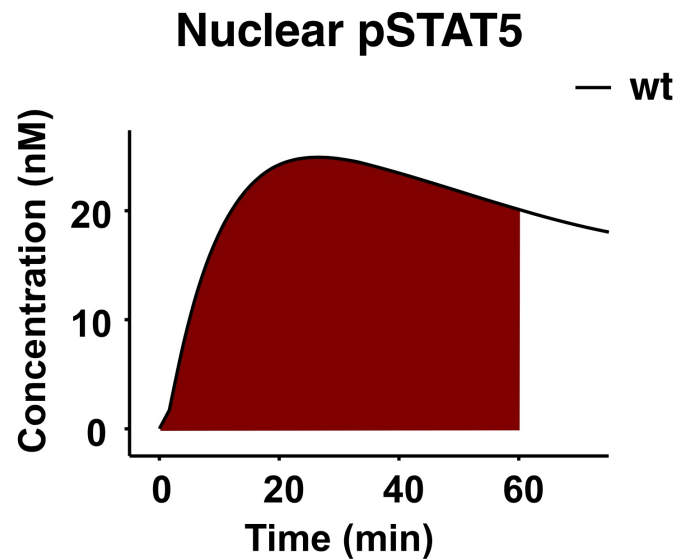

Dosing Effects

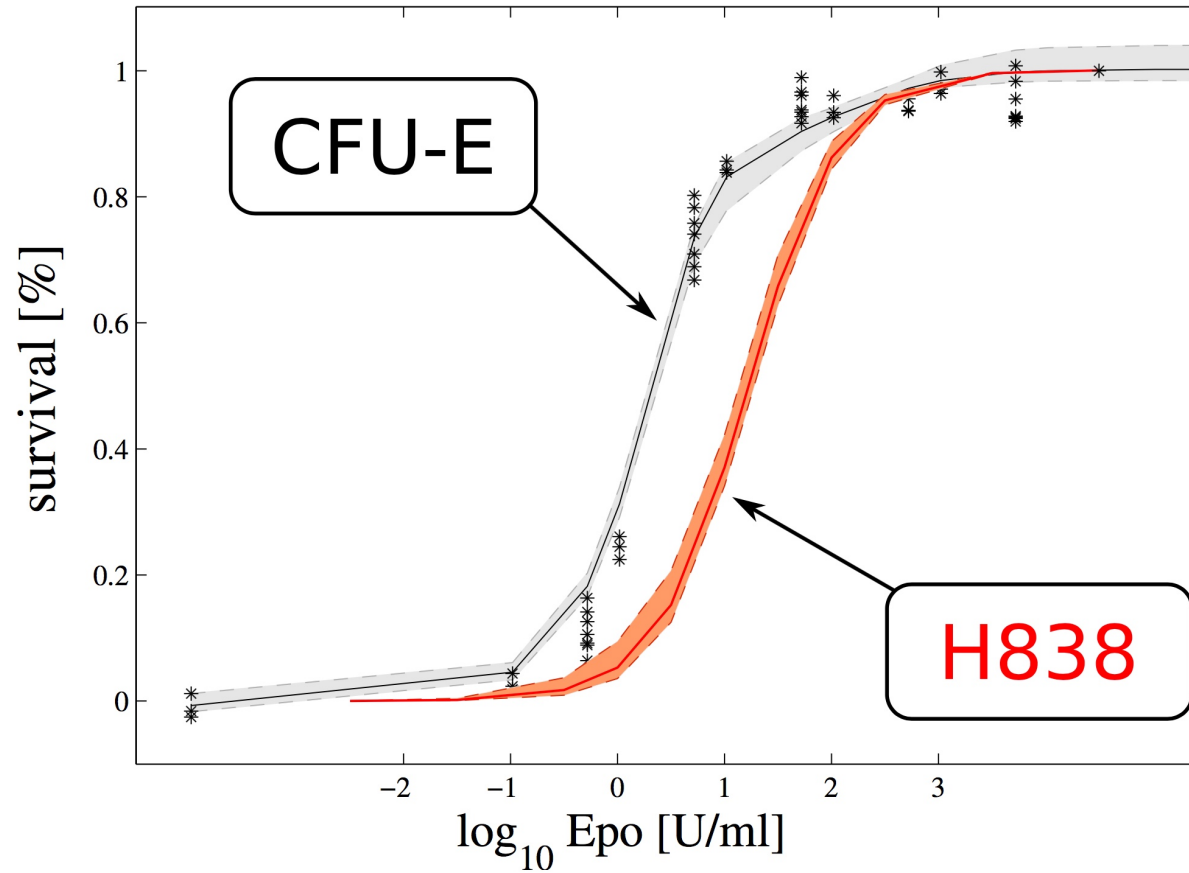

Suggests: There is a therapeutic window

C.E.R.A. Treatment of Anemic Lung Cancer Patients

- Chemotherapy may cause anemia
- NSCLC: Non-small cell lung carcinoma
- C.E.R.A.: Continuous Erythropoietin Receptor Activator Artificial Epo substitute, ©Roche
- Hb: Hemoglobin \propto number of red blood cells
- Hb = 12: fine
- Hb < 10: anemia
- Hb > 15: risk for cardio-vascular events

Multi-Scale Model Extension

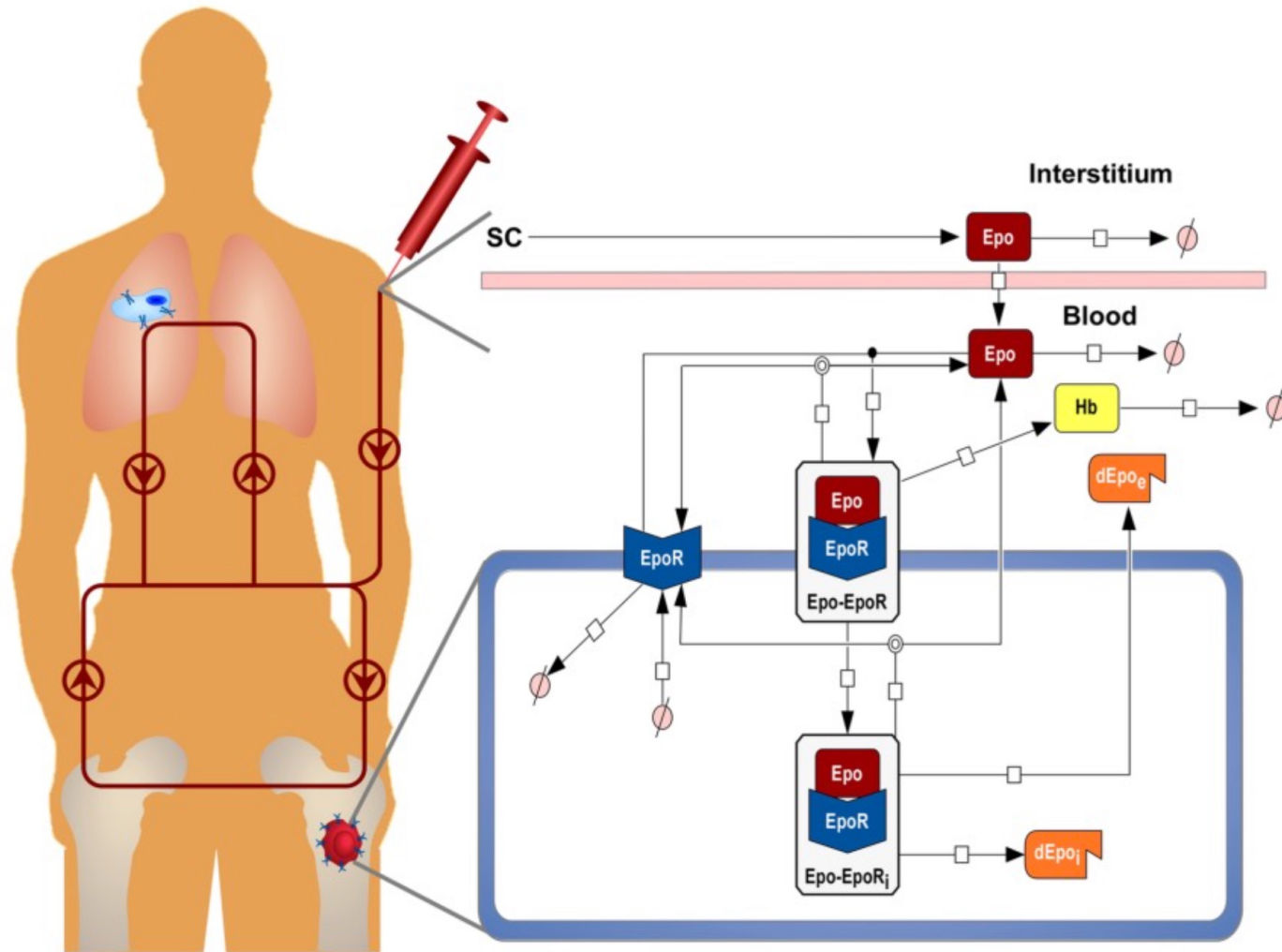

Model Calibration

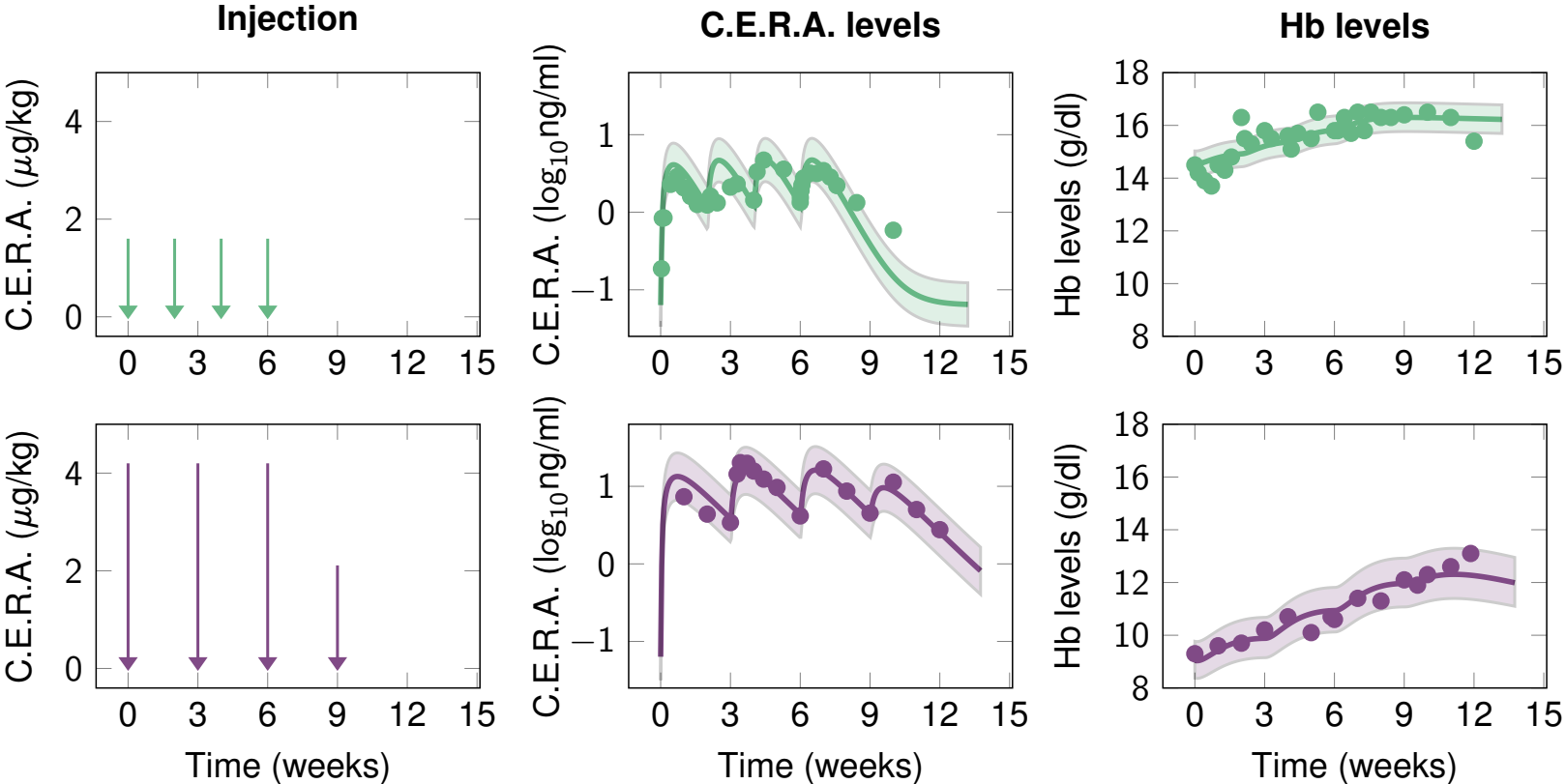

Patient-specific Parameters

Statistics: Two patient-specific parameters

- **Number of ESA binding sites**

Corresponds to number of CFU-E cells

- **Hemoglobin degradation rate**

Reflects inflammatory effects

Patient-specific Parameters

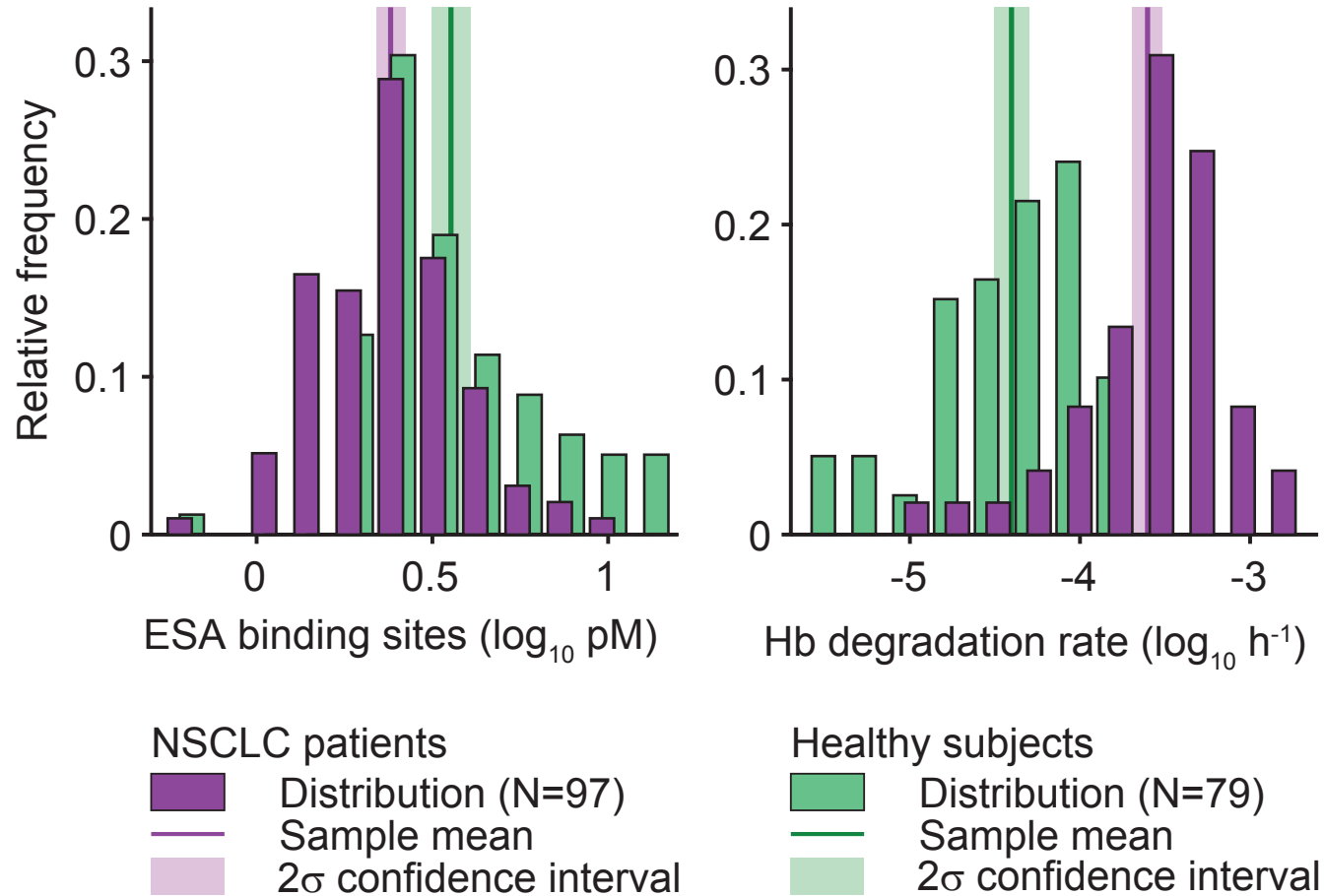

Opposing Therapeutic Goals

- Increase Hb level (not too) rapidly to treat anemia
- Avoid overdosing to prevent adverse events

Current dosing scheme :

- Initialize treatment with a fixed dose for Hb below 10 g/dl
- Halve the dose for Hb above 12 g/dl
- Terminate treatment for Hb above 13 g/dl
- Re-start with 25% of initial dose if Hb below 13 g/dl
- Continue with 50% of initial dose if Hb below 12 g/dl

Current Dosing Scheme

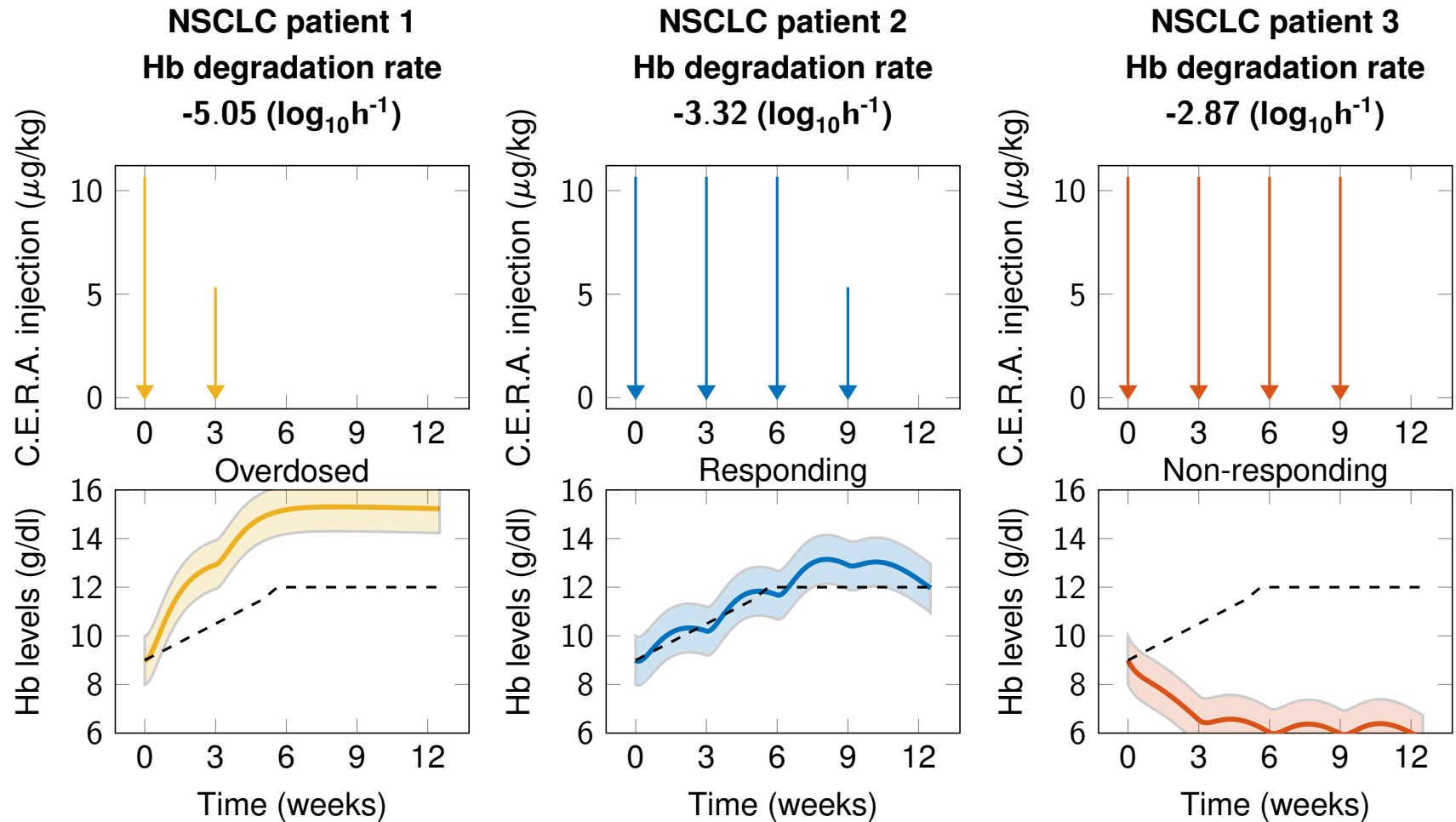

Patient Stratification

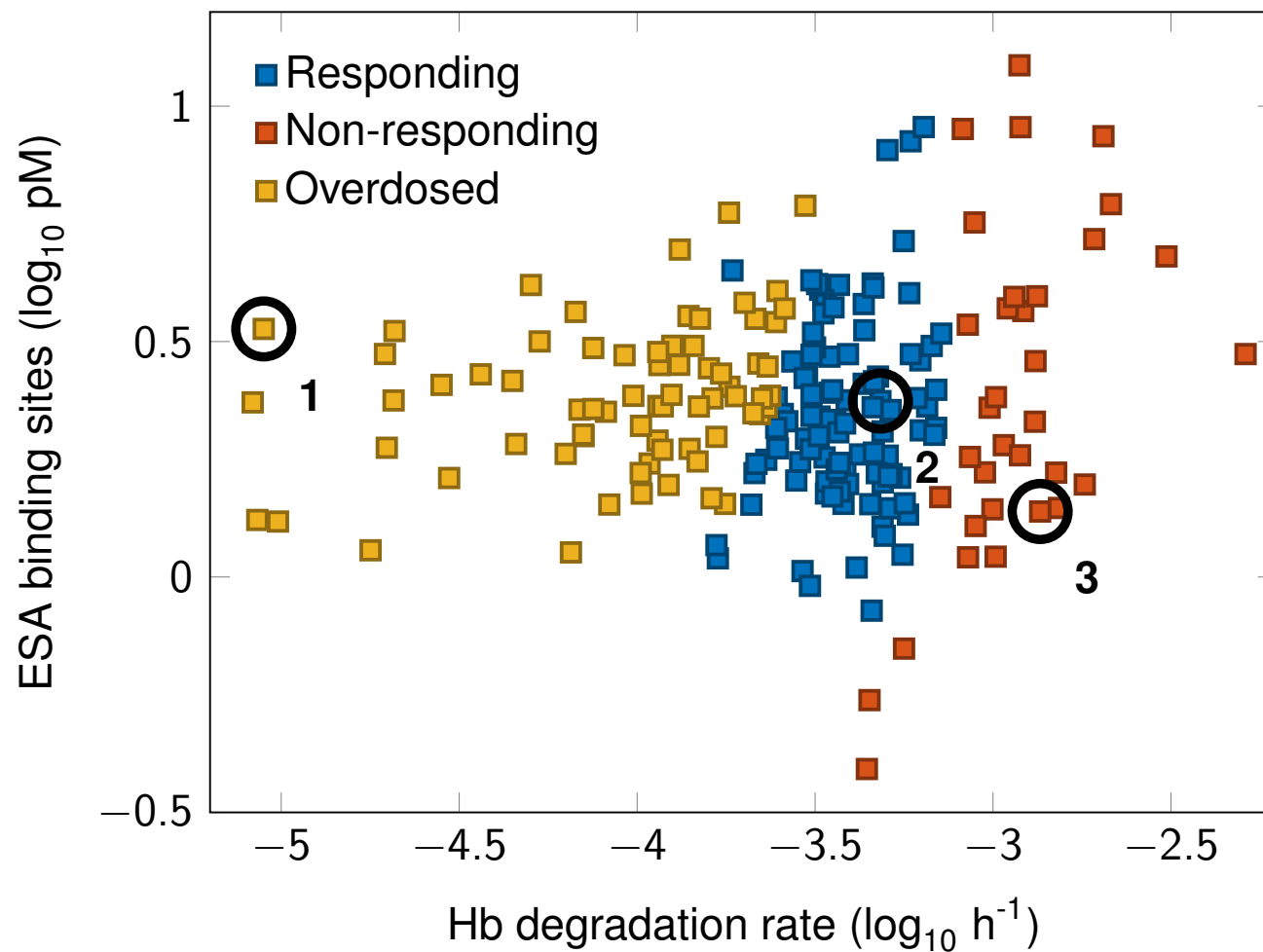

Model-based Personalized Dosing Strategy

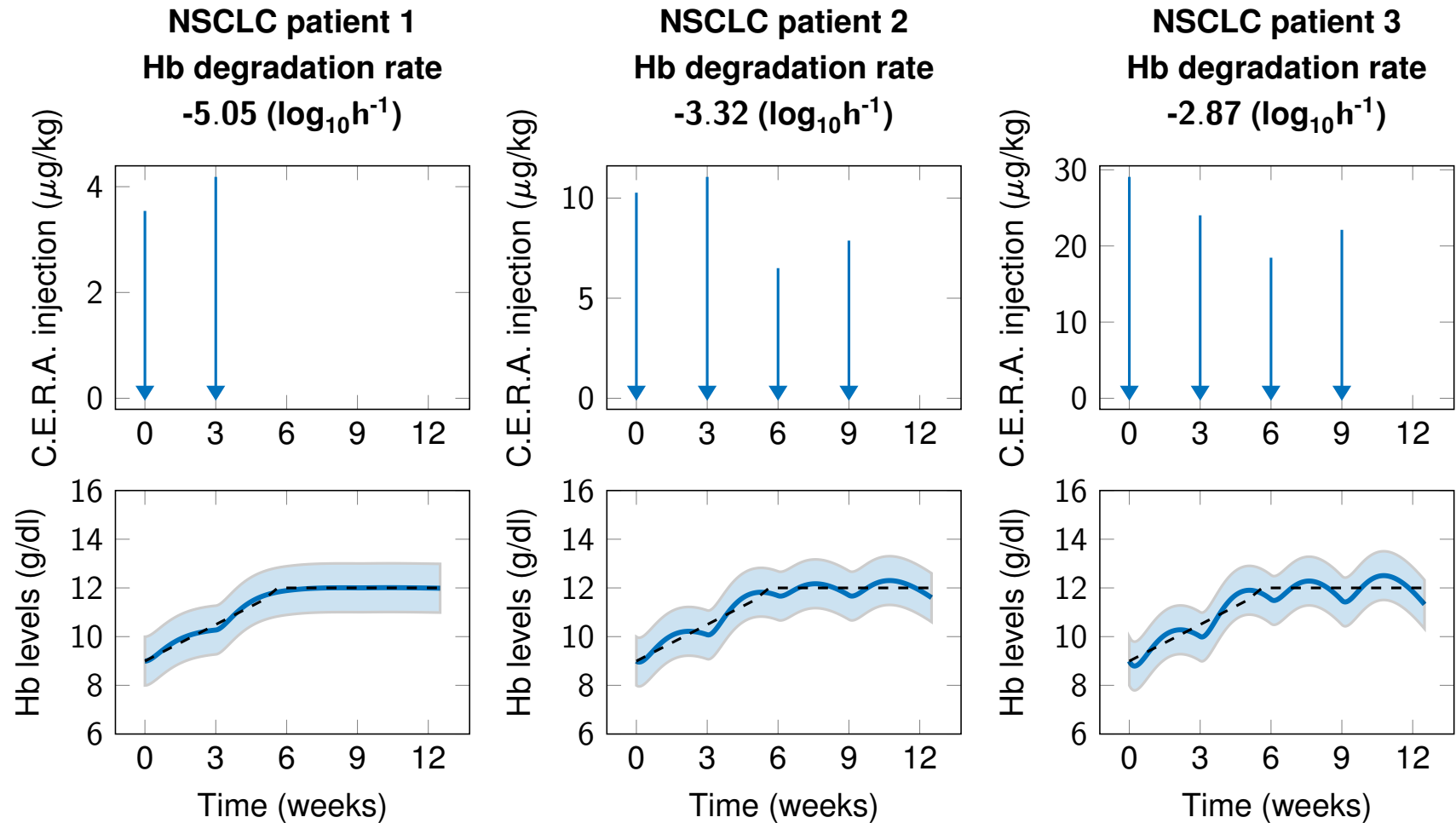

Model-based Personalized Dosing Strategy

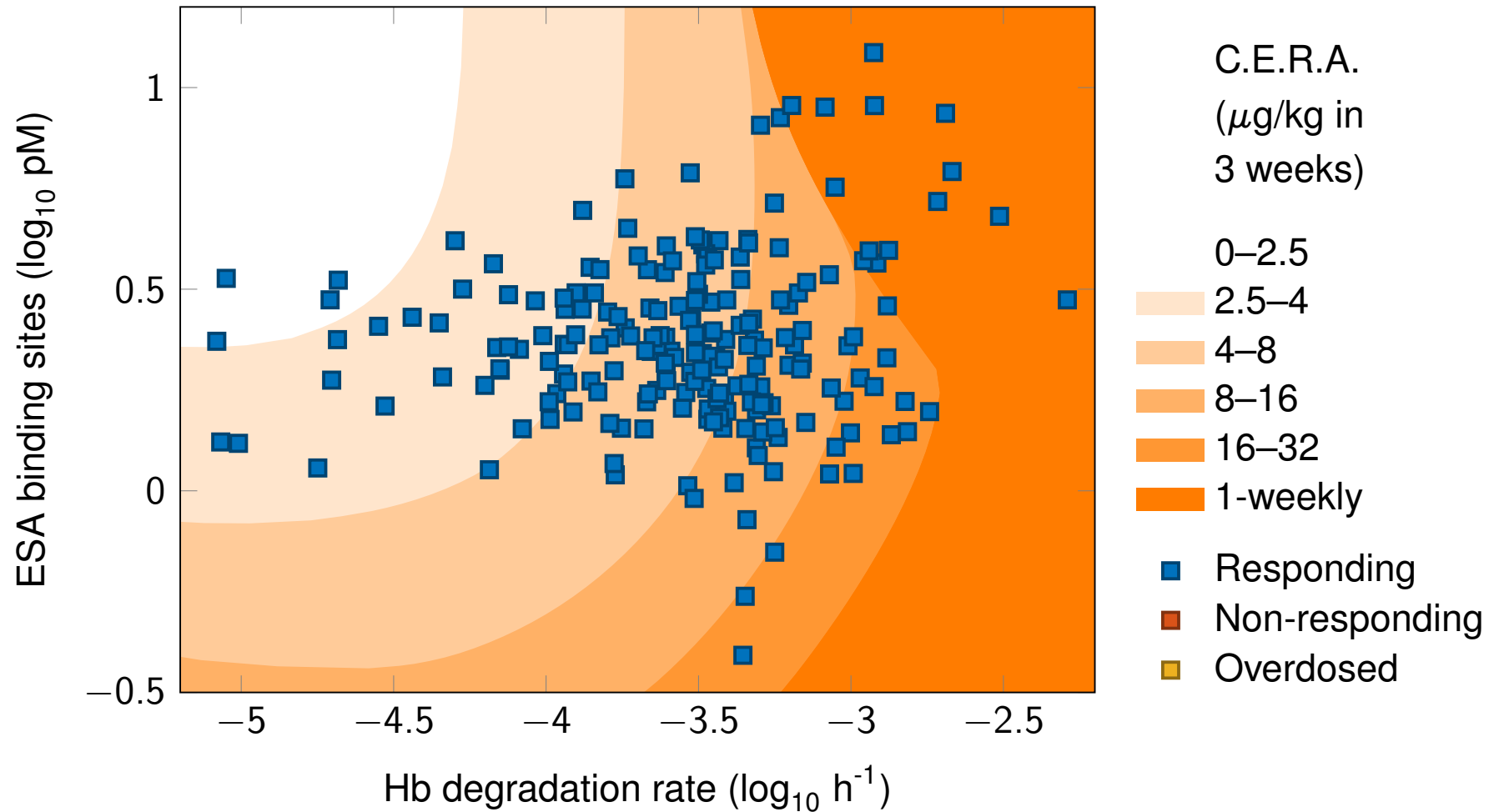

Online Dosing Strategy

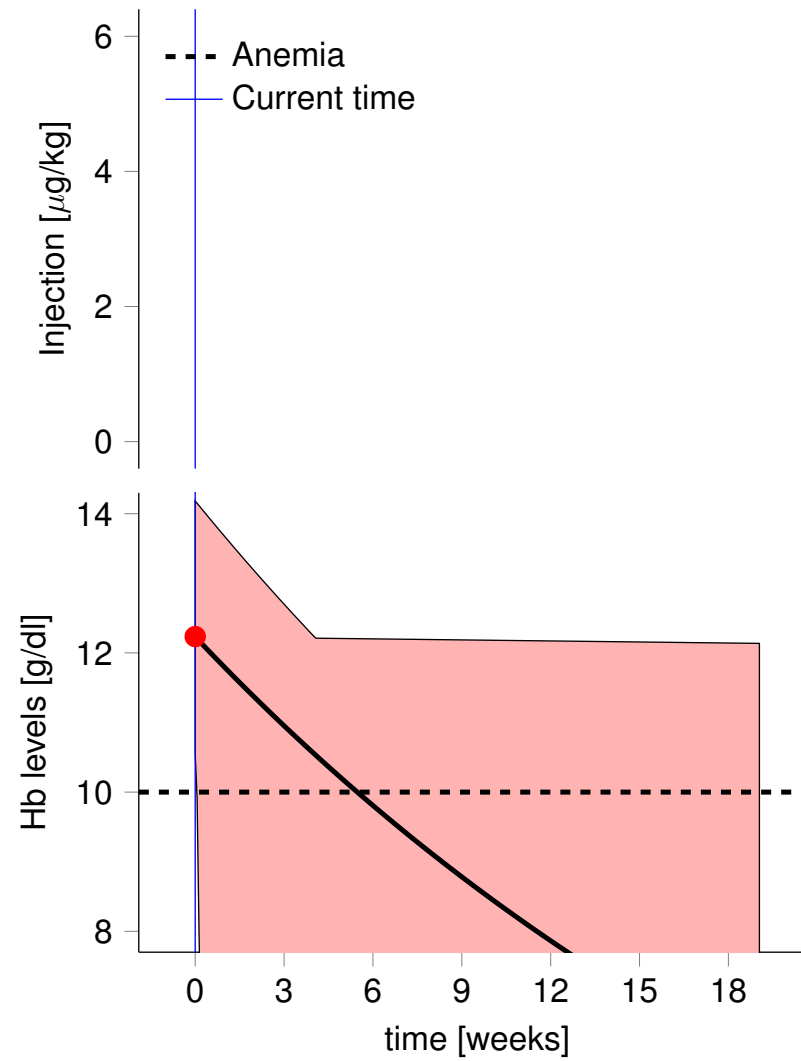

Measurement 2: pre-anemic situation

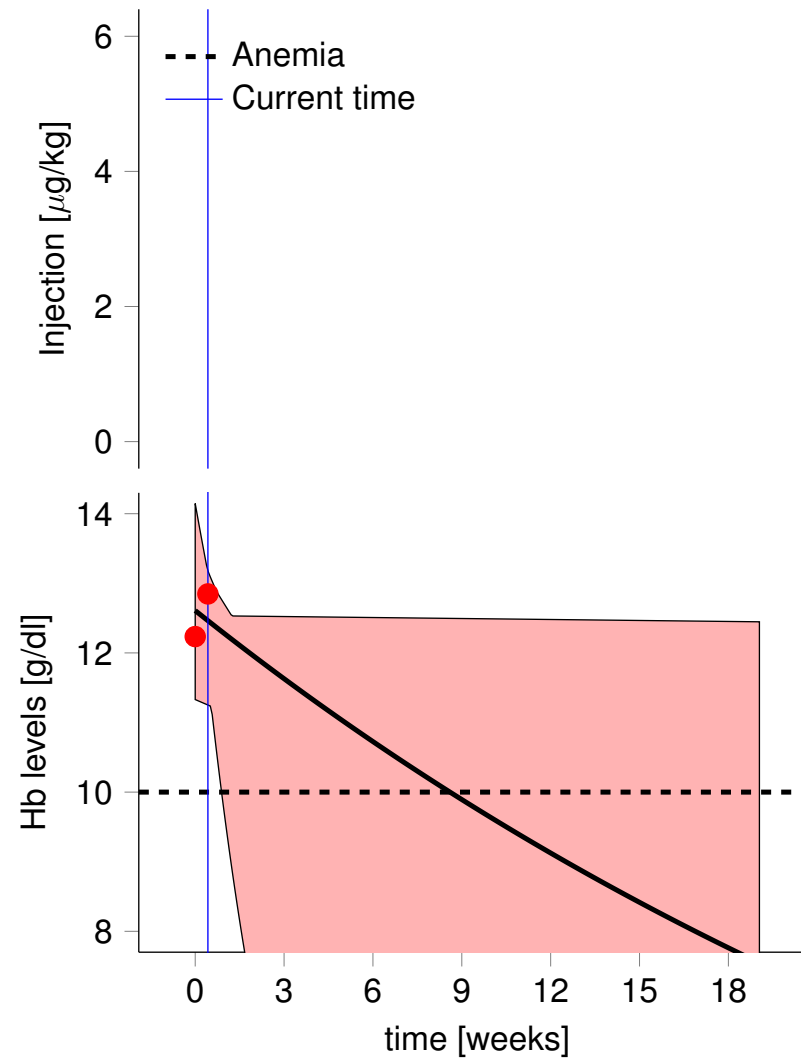

Measurement 3: pre-anemic situation

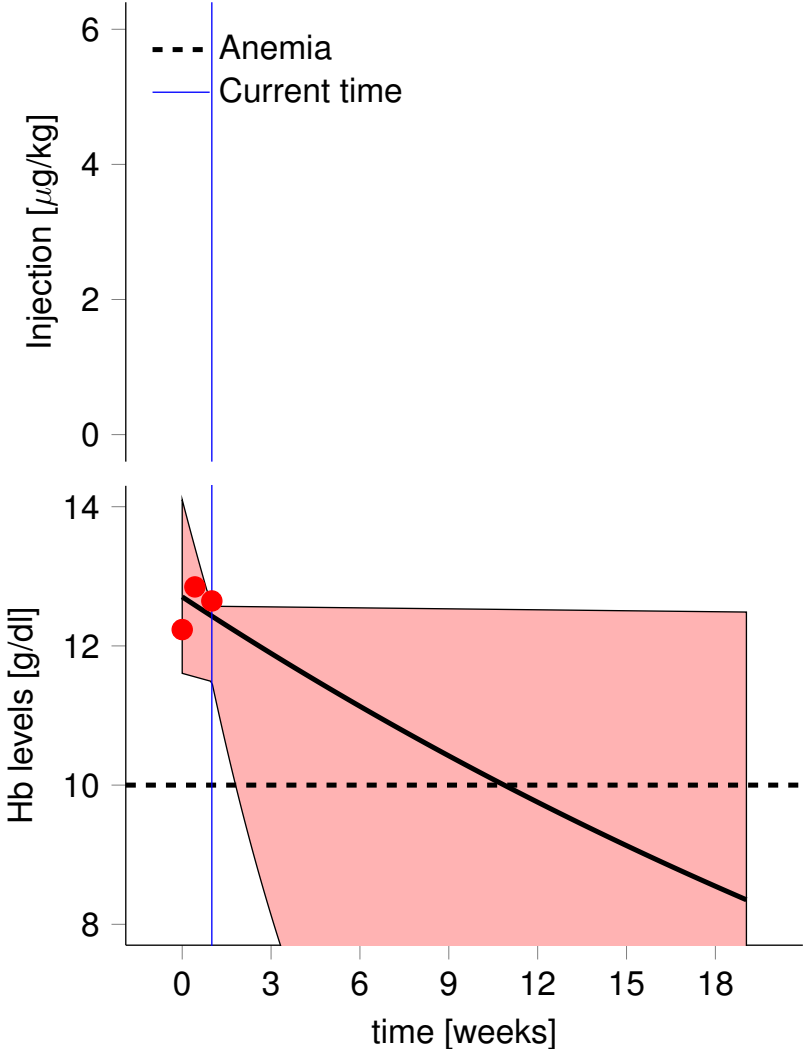

Measurement 4: pre-anemic situation

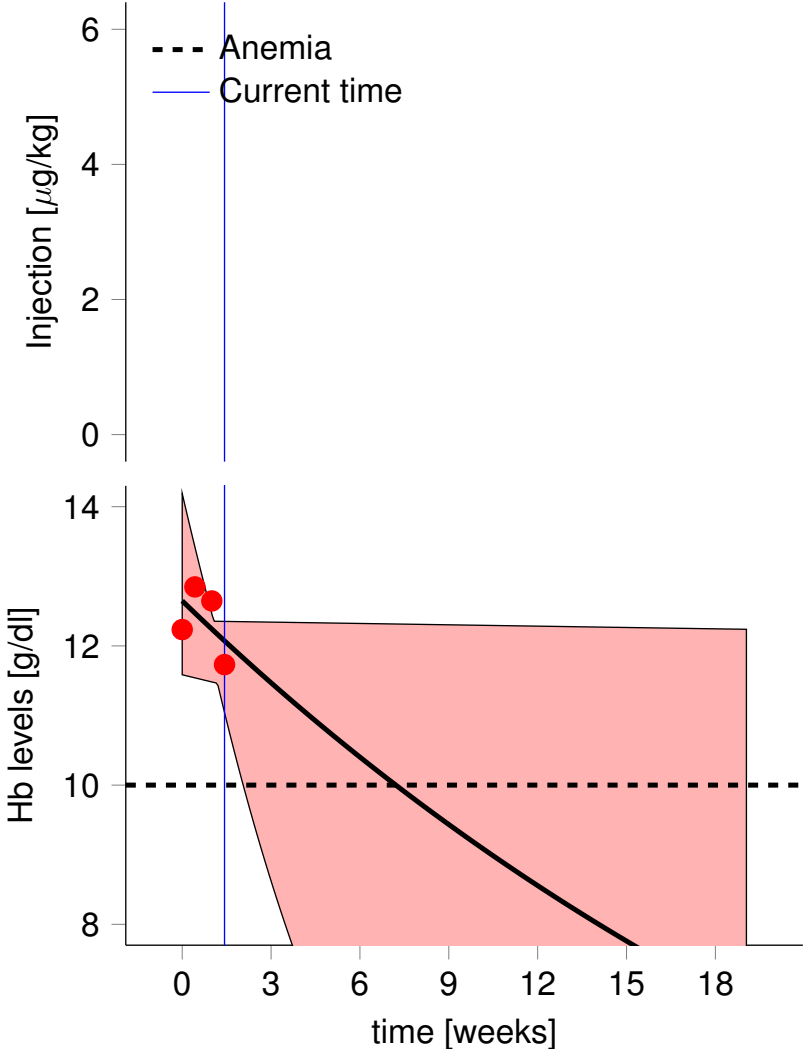

Measurement 5: pre-anemic situation

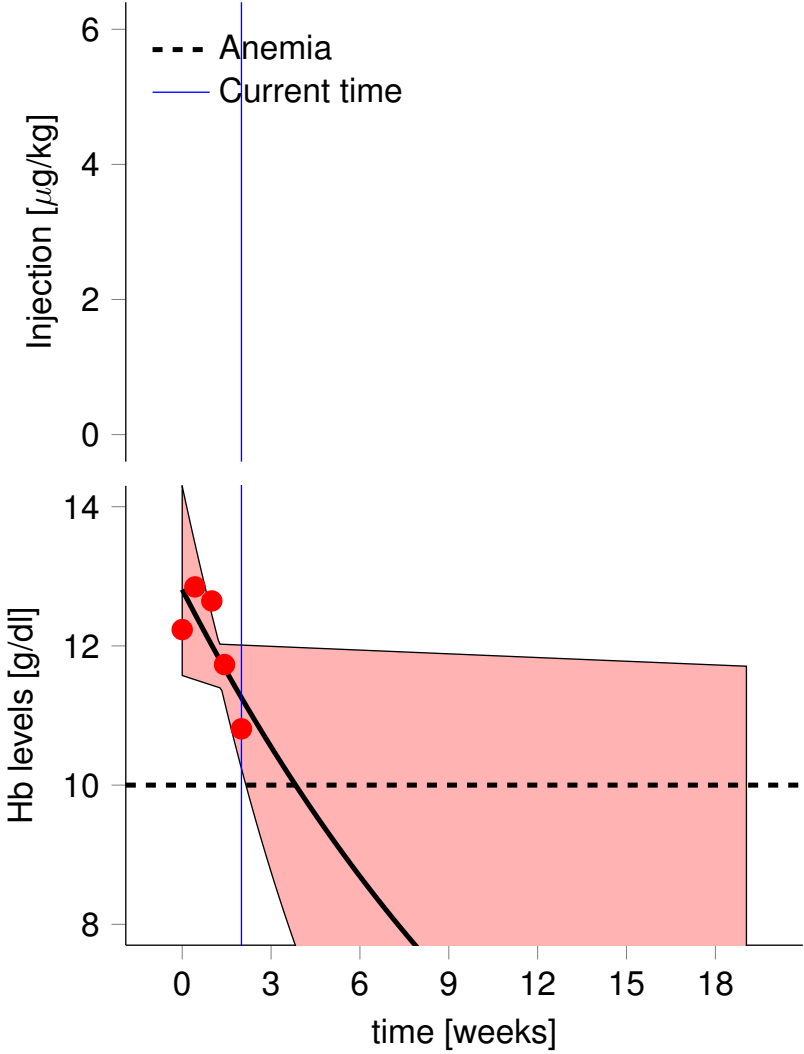

Measurement 6: pre-anemic situation

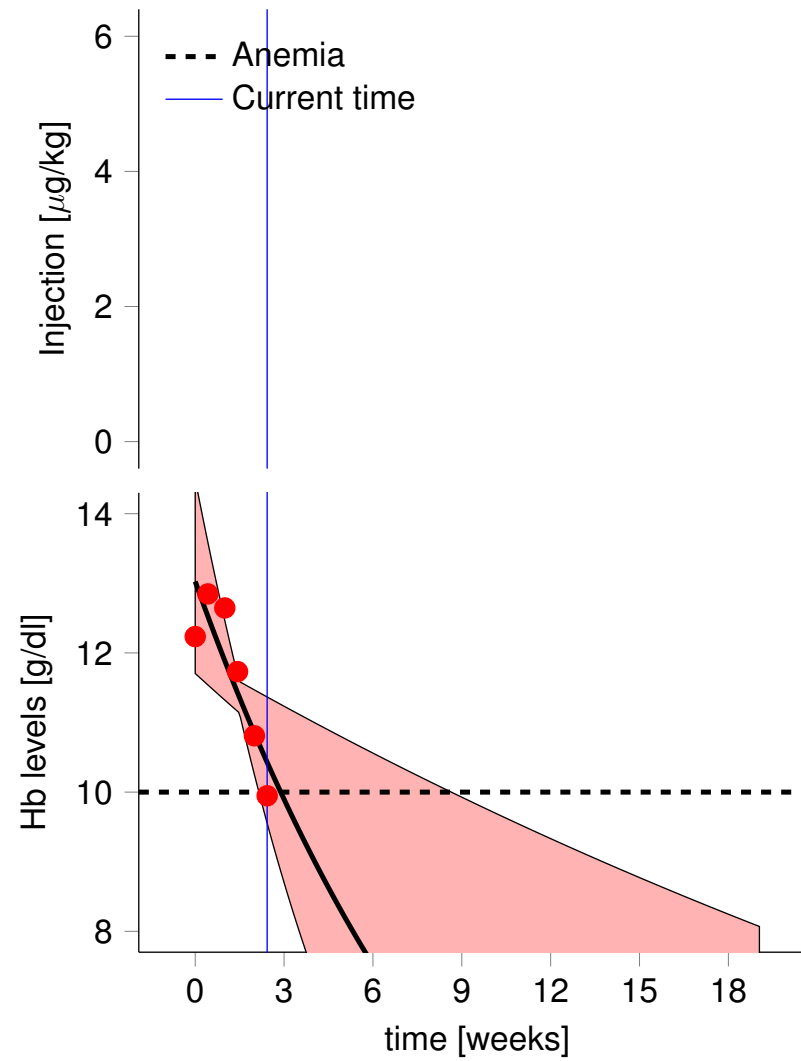

Measurement 7: pre-anemic situation

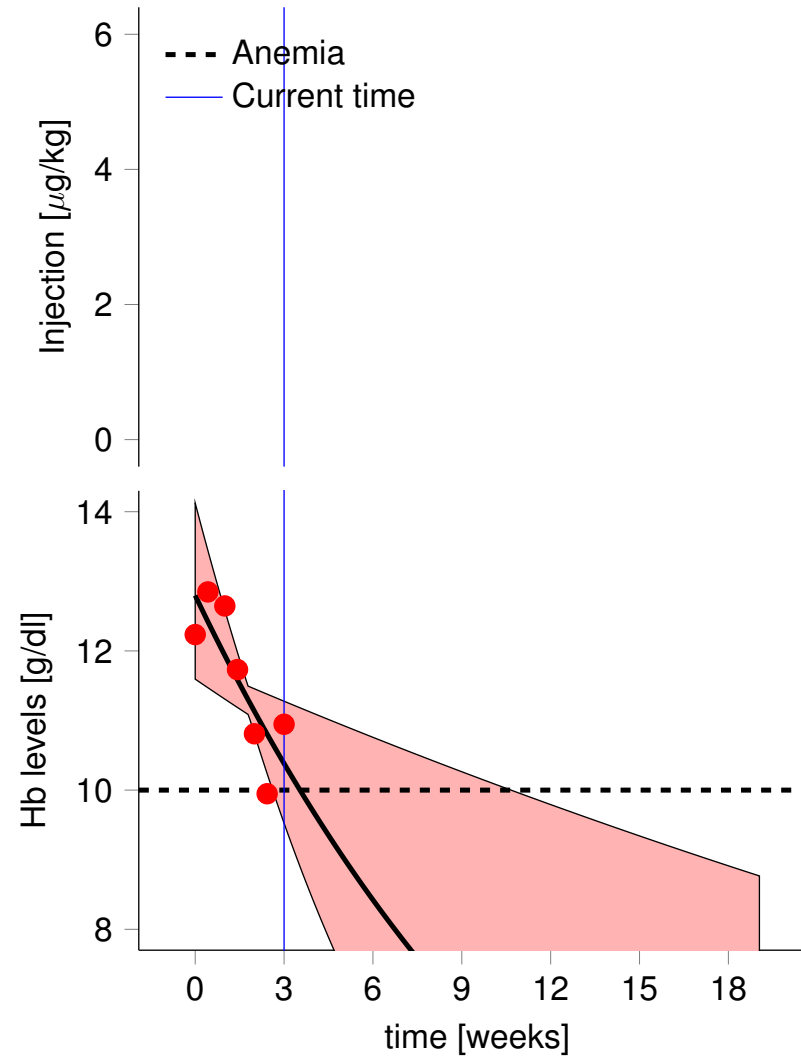

Measurement 8: pre-anemic situation

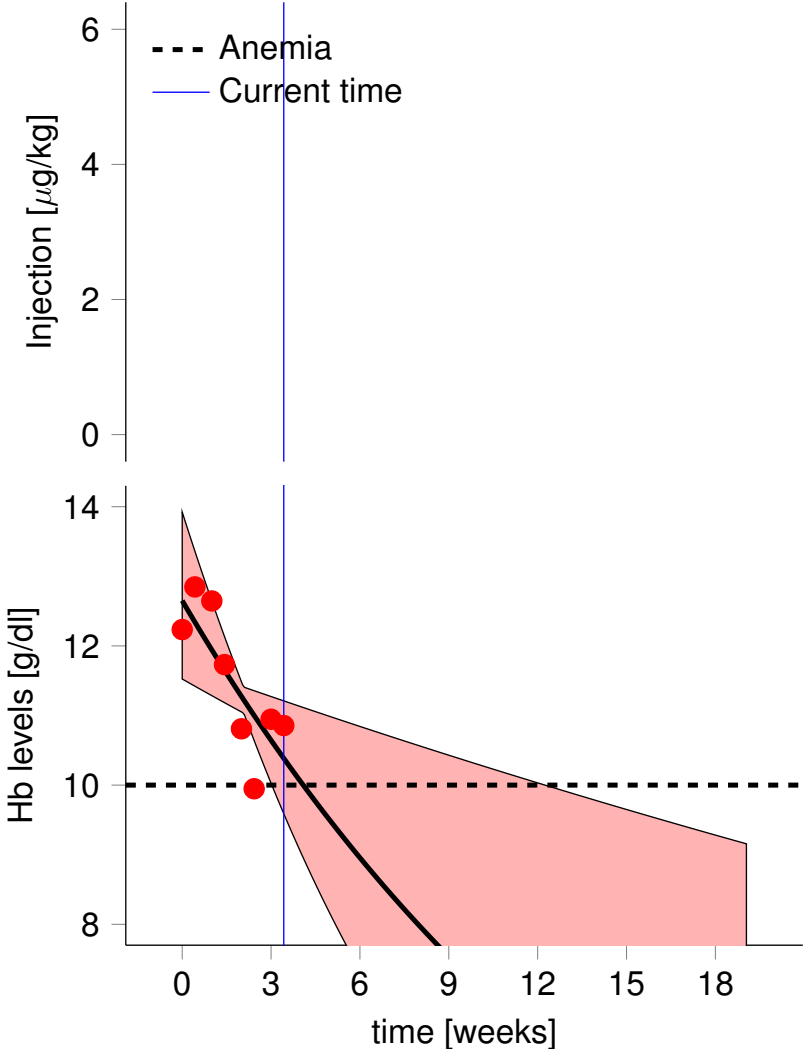

Measurement 9: pre-anemic situation

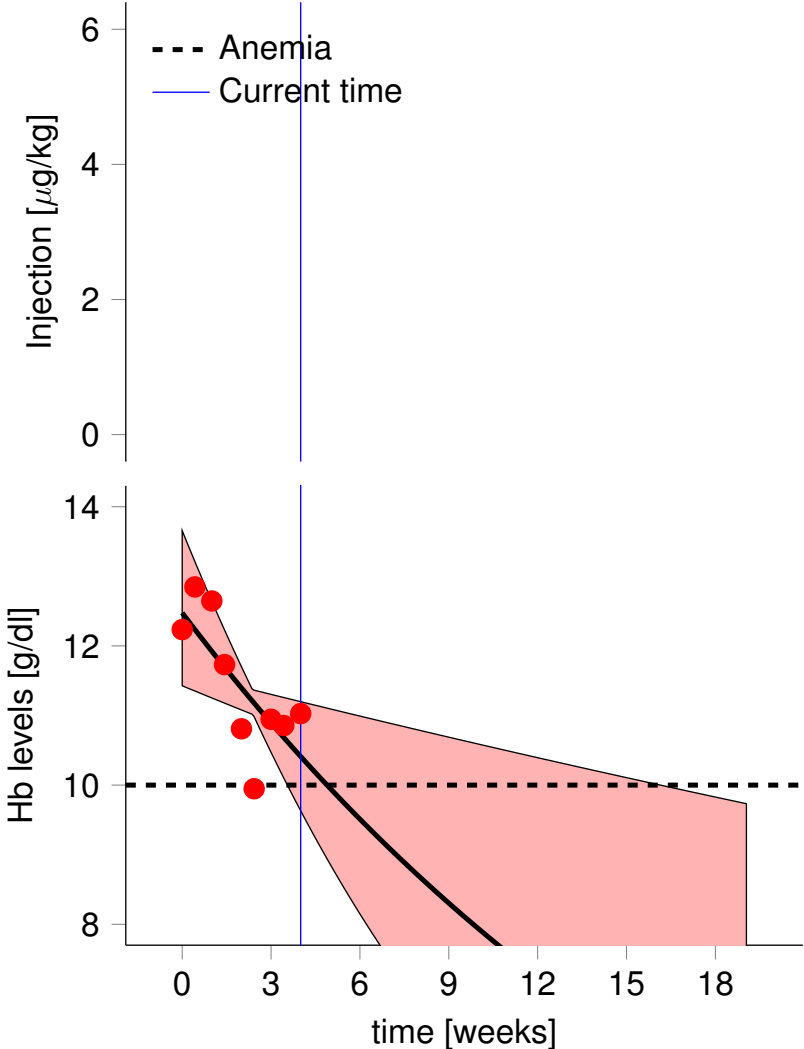

Measurement 10: pre-anemic situation

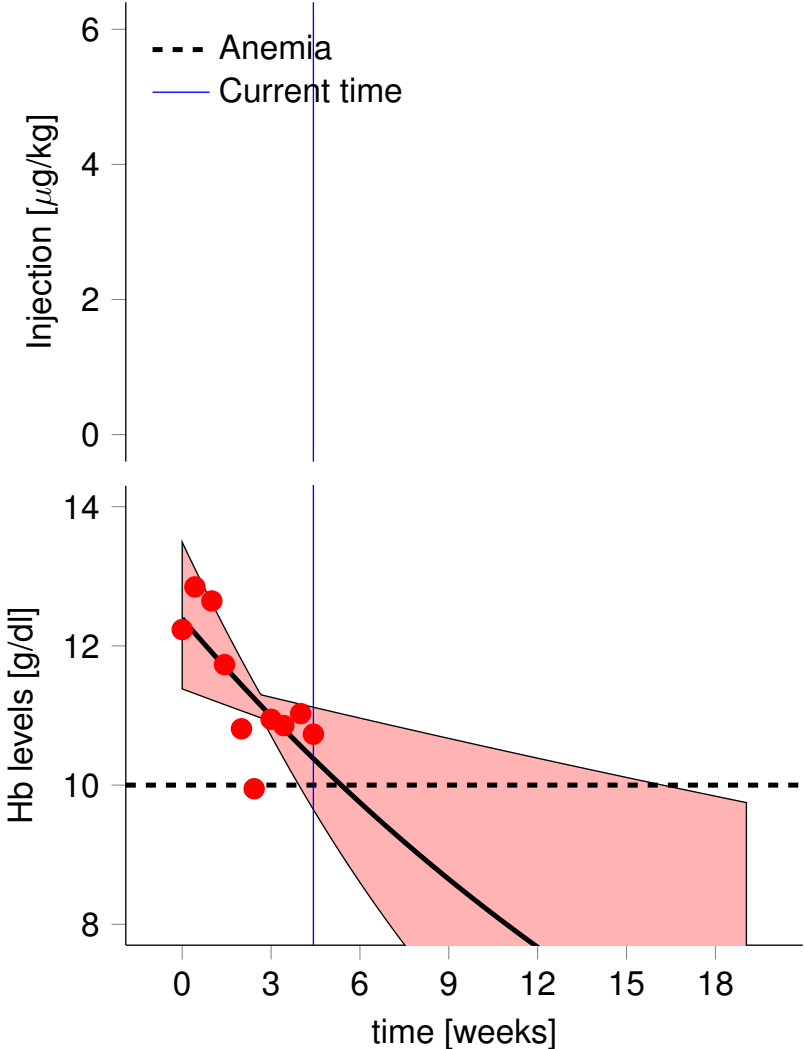

Measurement 11: pre-anemic situation

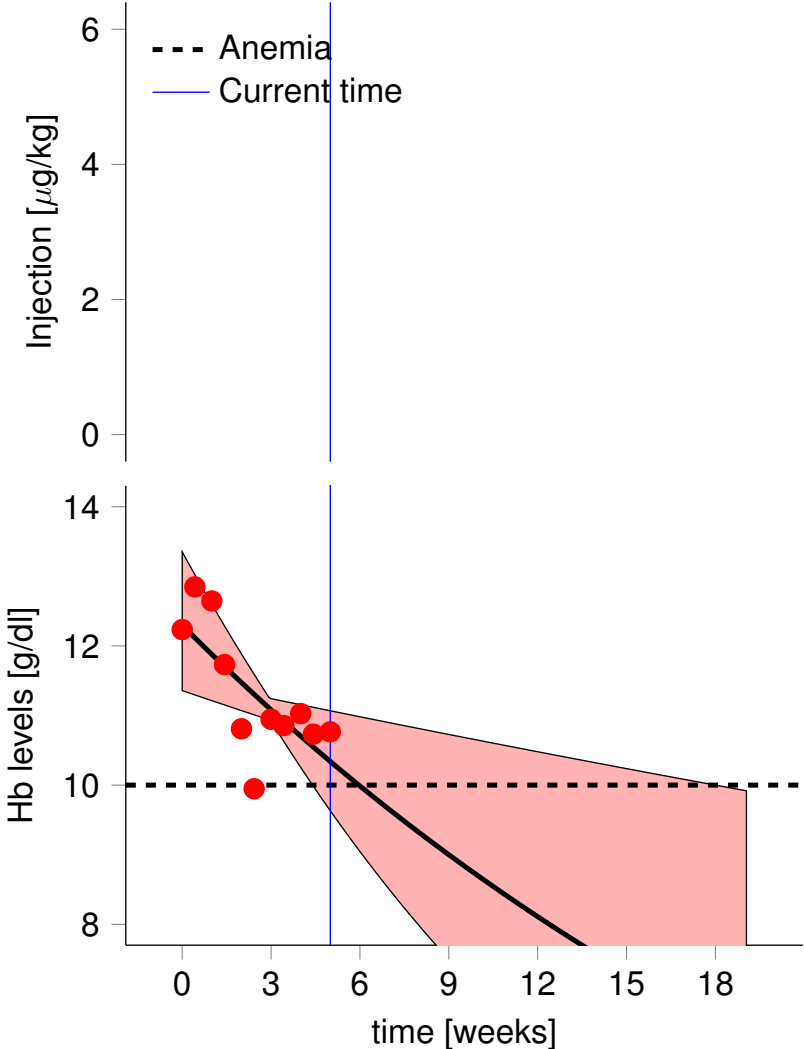

Measurement 12: pre-anemic situation

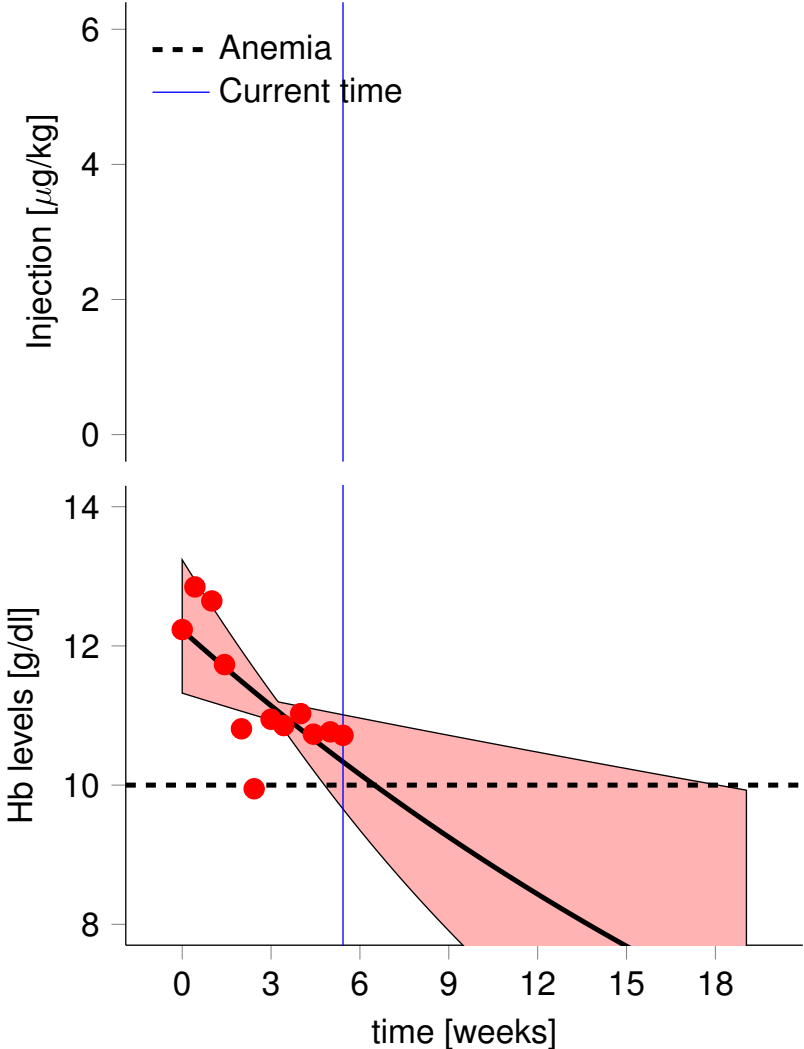

Measurement 13: pre-anemic situation

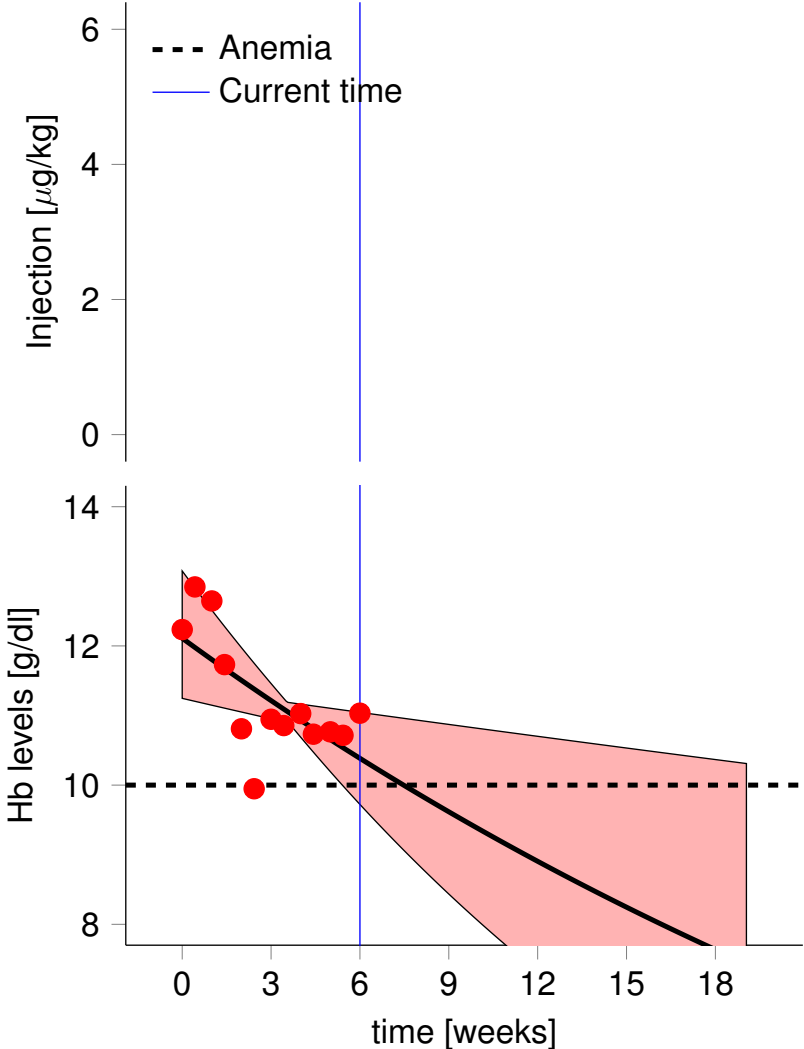

Measurement 14: pre-anemic situation

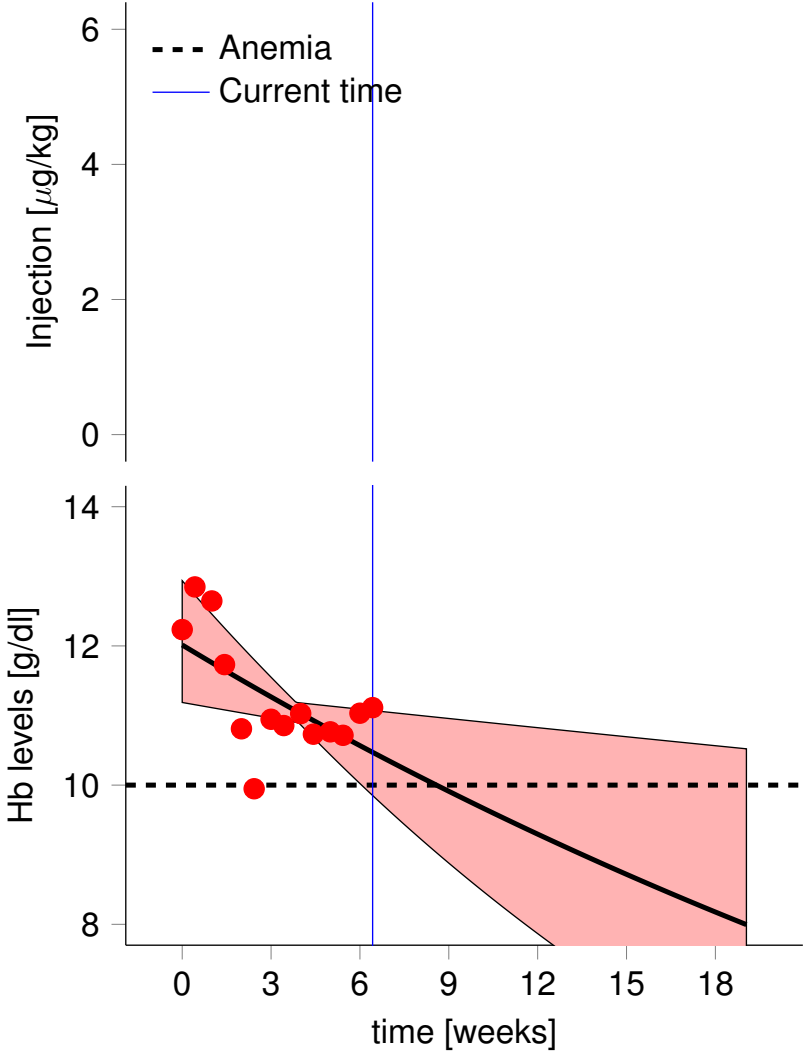

Measurement 15: pre-anemic situation

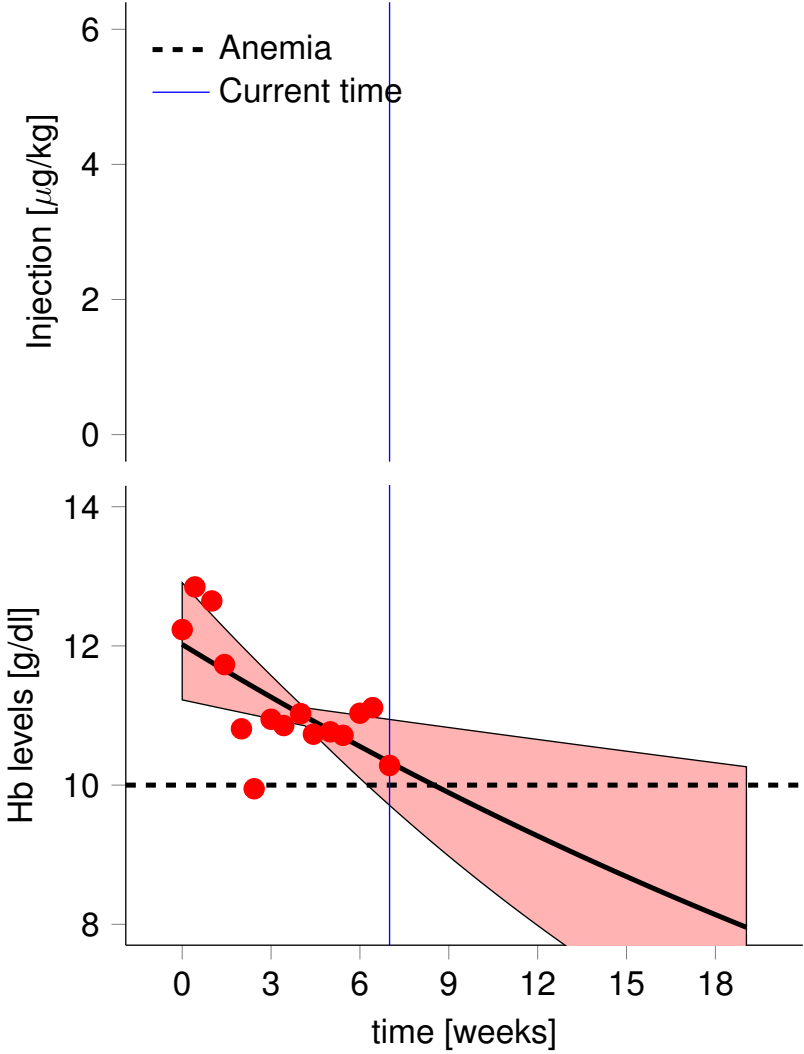

Measurement 16: pre-anemic situation

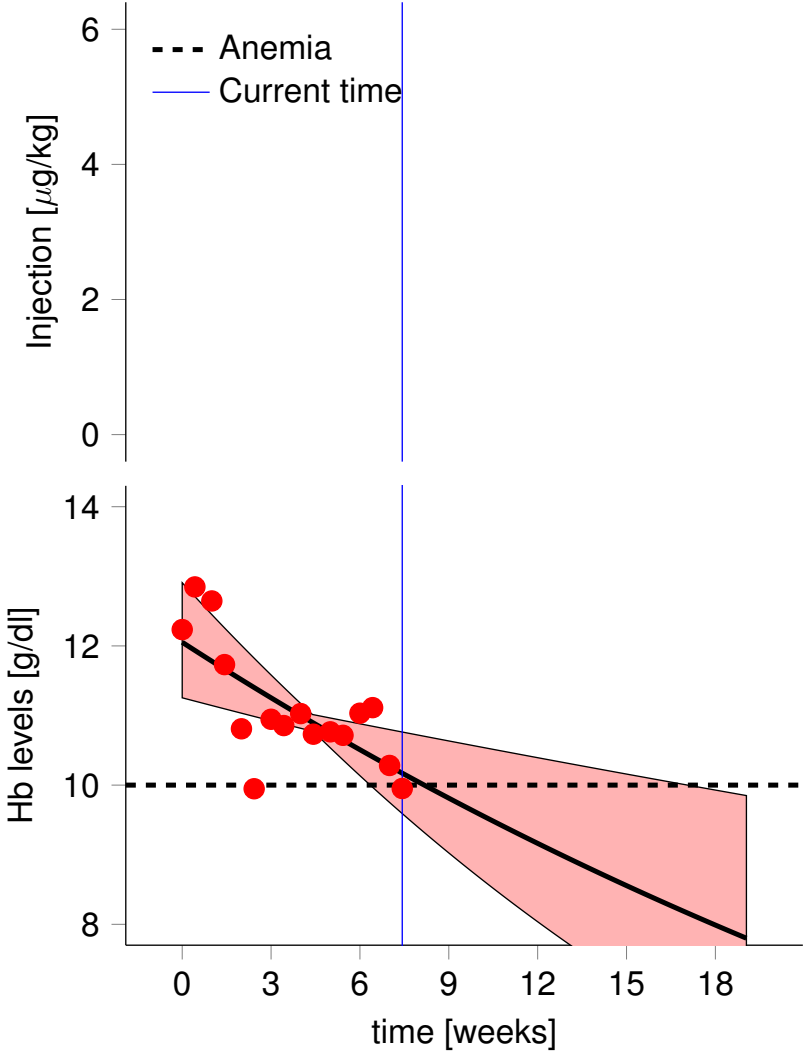

Measurement 17: anemia diagnosed

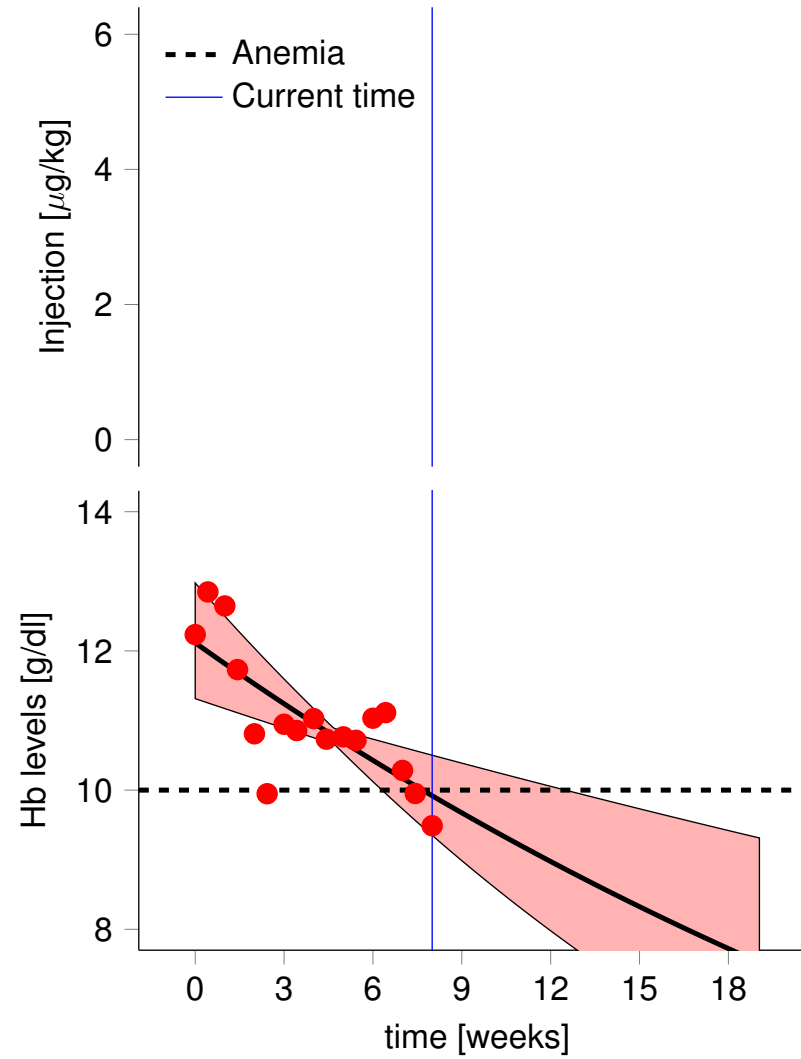

Injection of C.E.R.A.

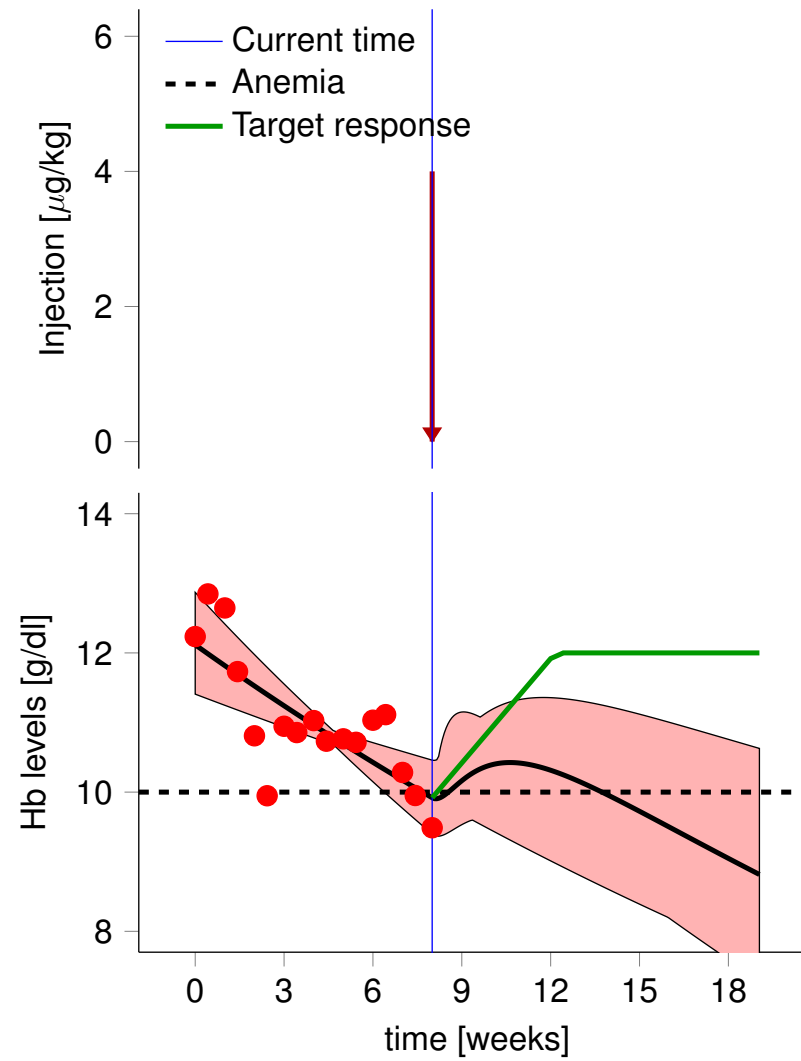

Measurement 17: treatment design

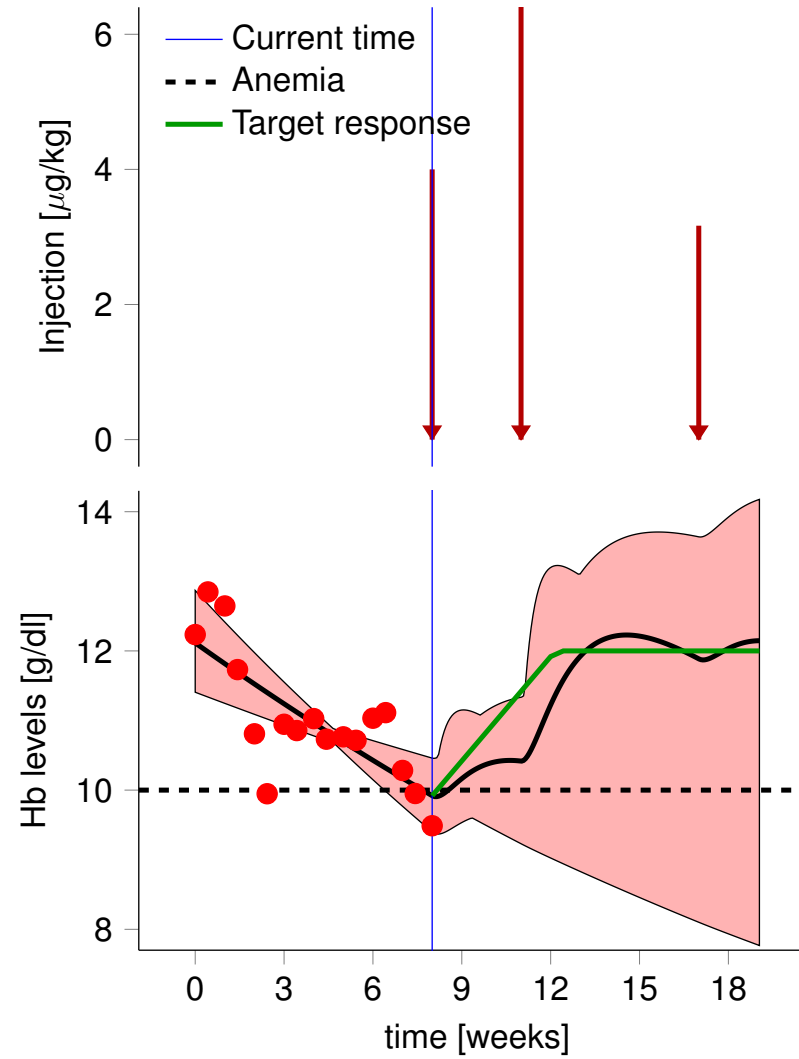

Measurement 18: treatment design

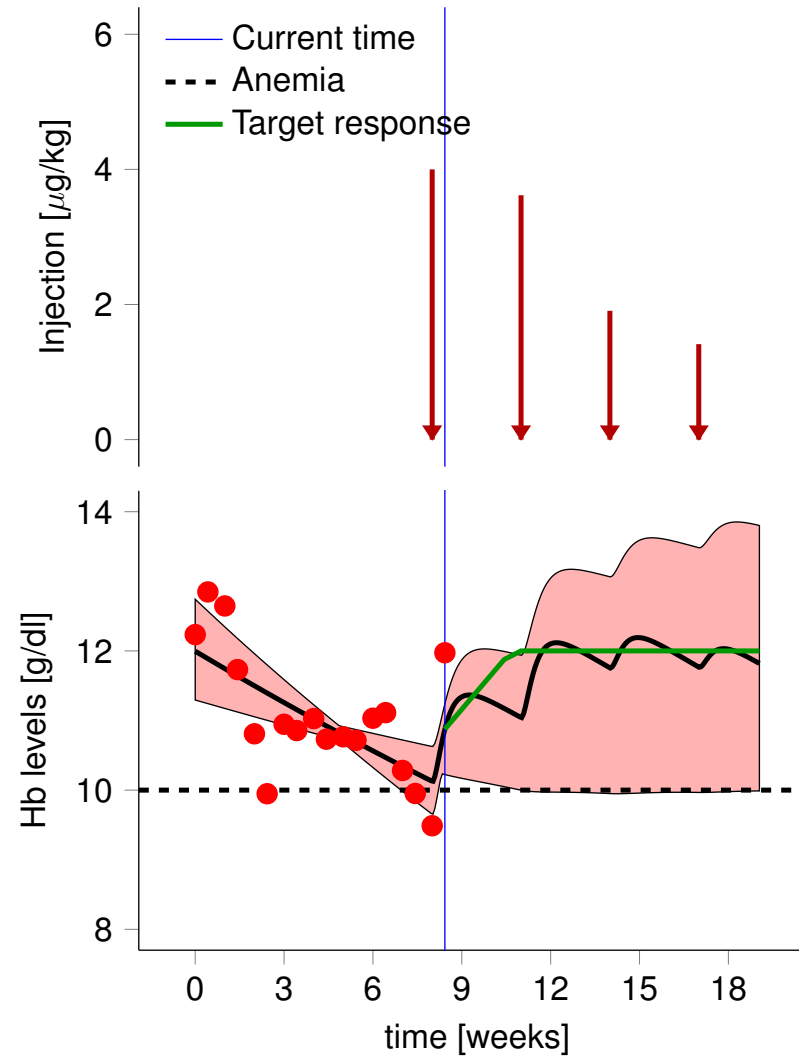

Measurement 19: treatment design

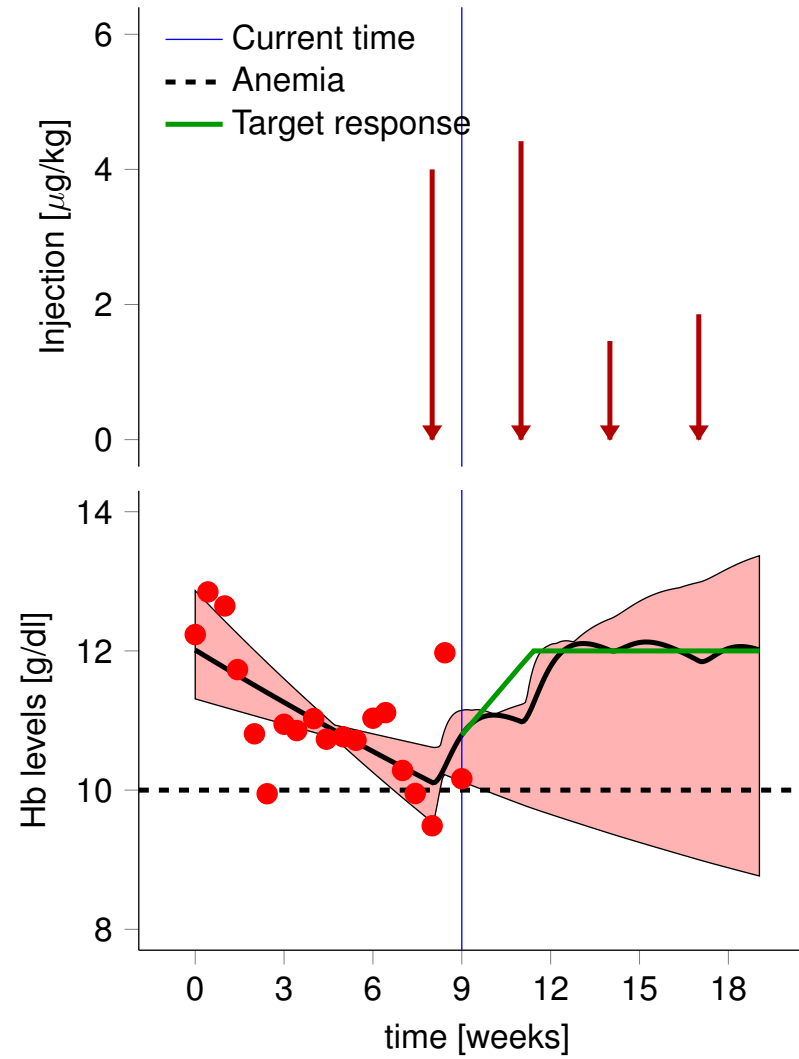

Measurement 20: treatment design

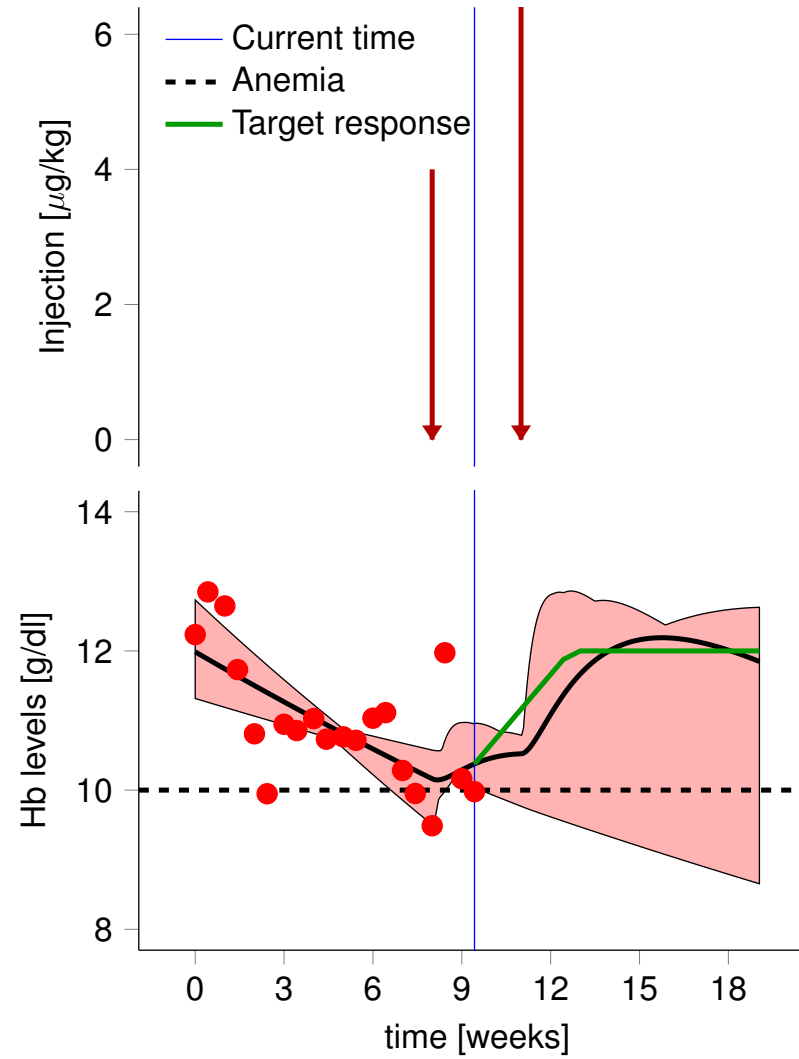

Measurement 21: treatment design

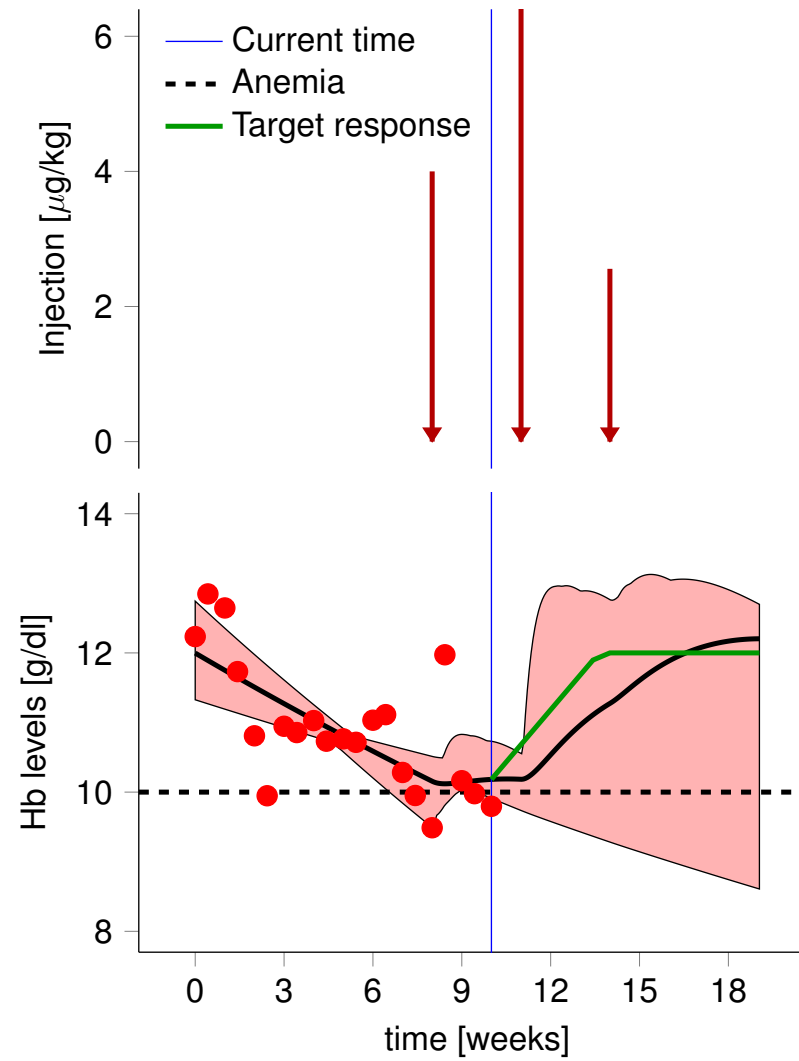

Measurement 22: treatment design

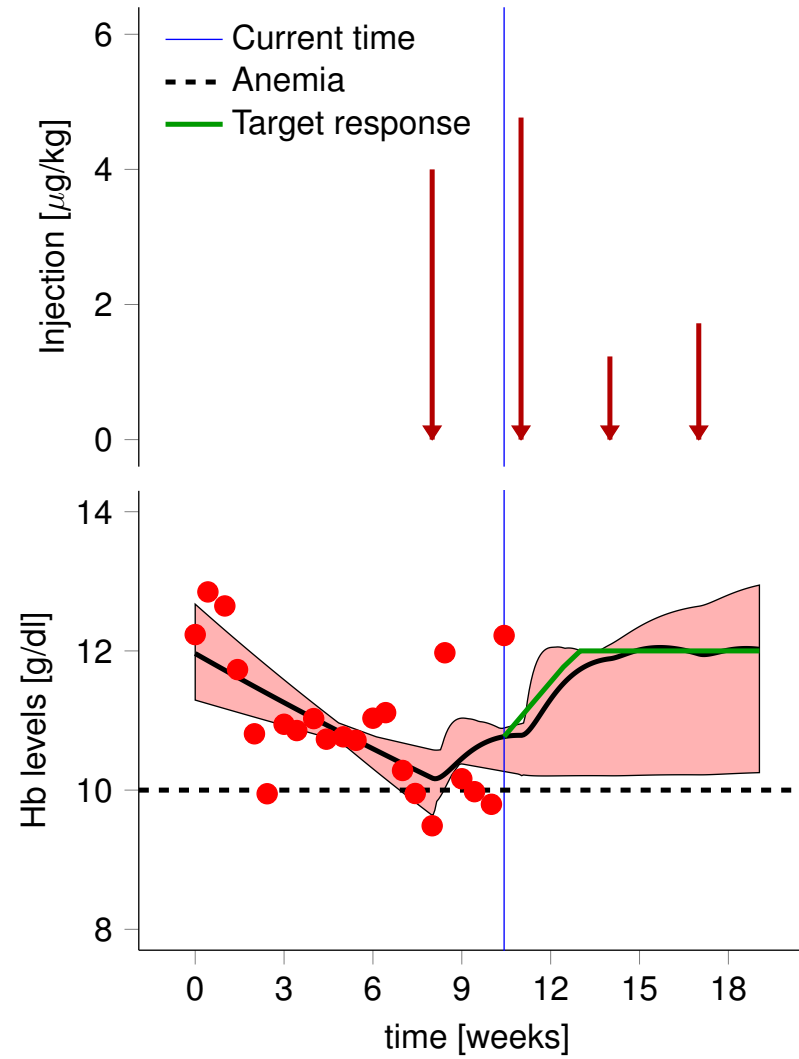

Measurement 23: treatment design

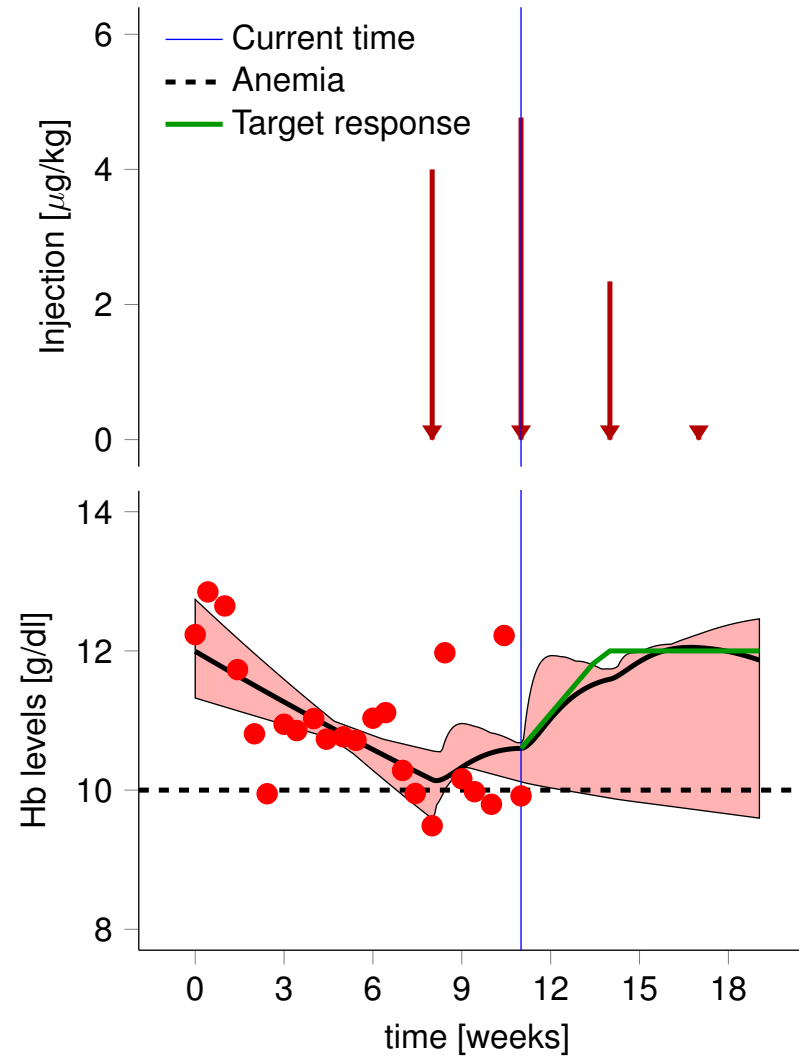

Measurement 24: treatment design

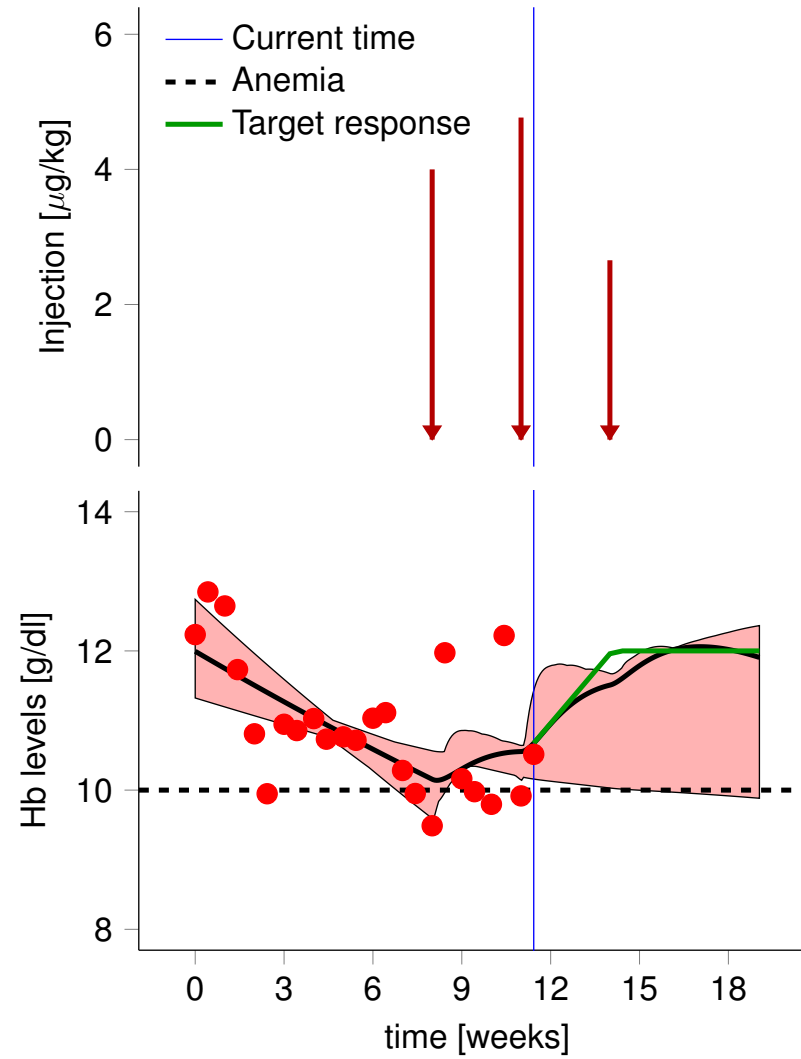

Measurement 25: treatment design

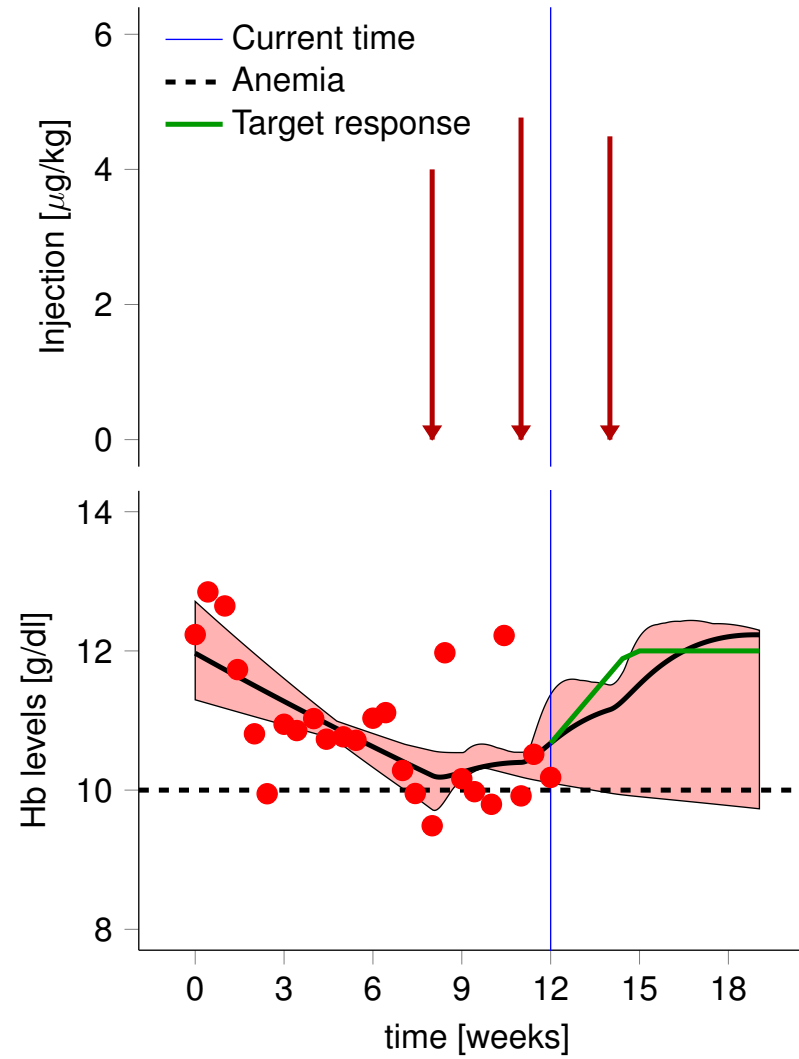

Measurement 26: treatment design

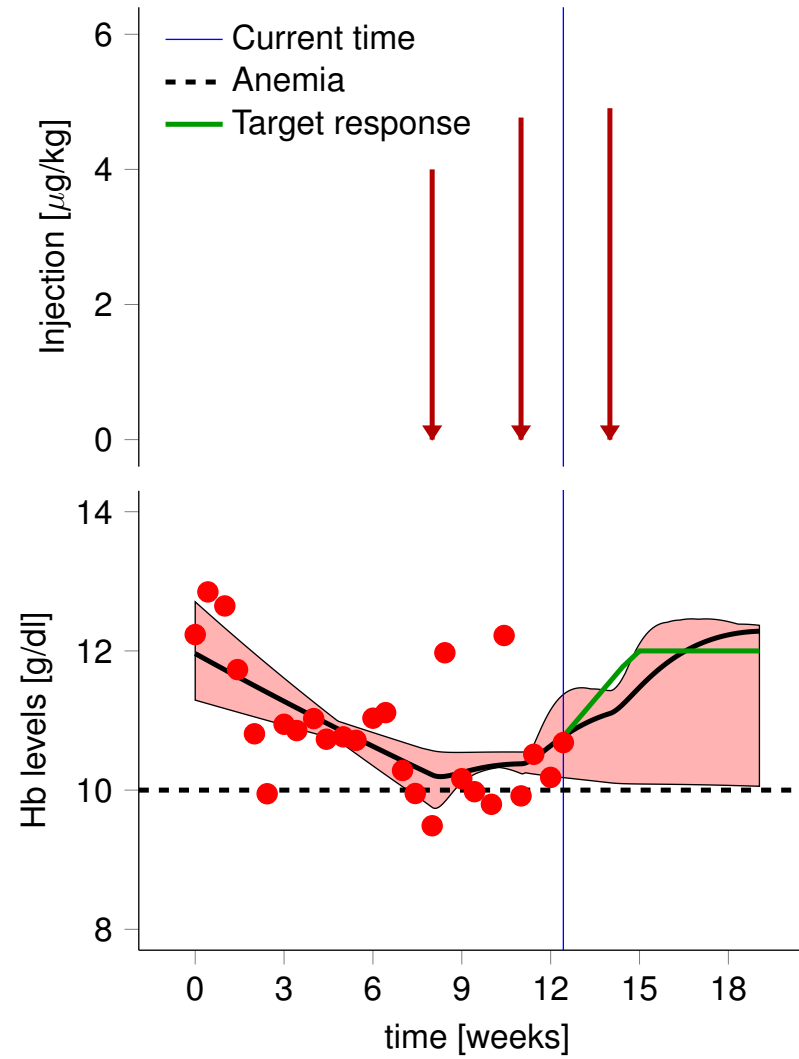

Measurement 27: treatment design

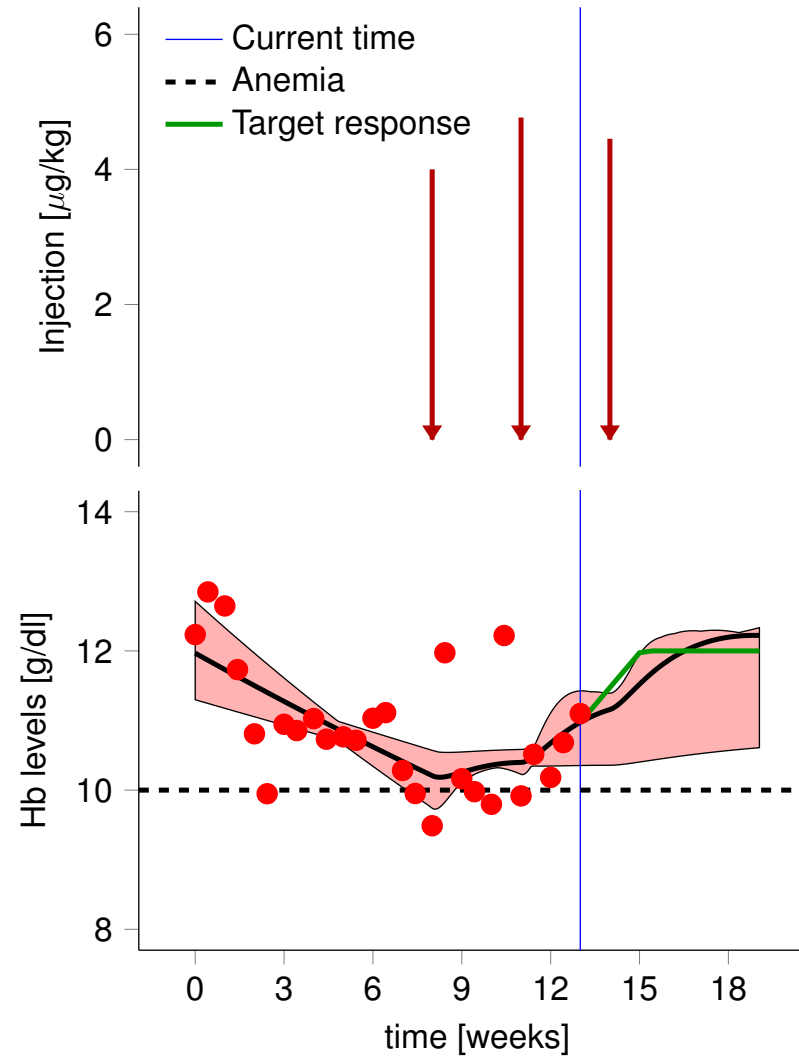

Measurement 28: treatment design

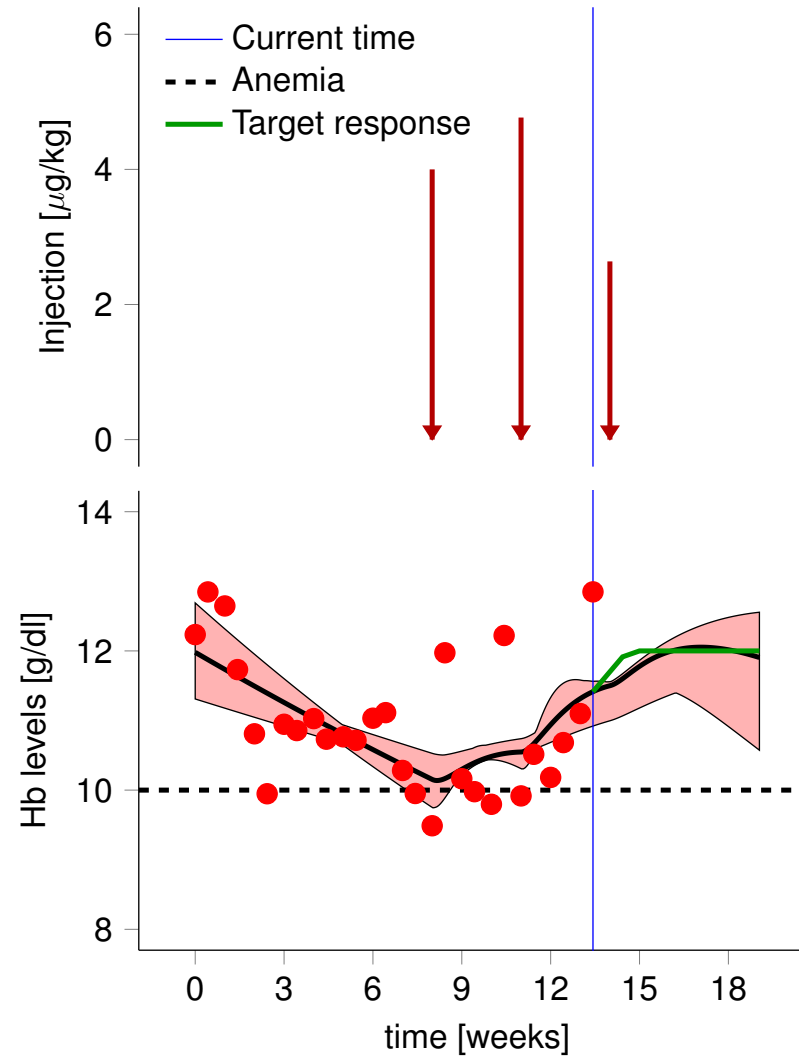

Measurement 29: treatment design

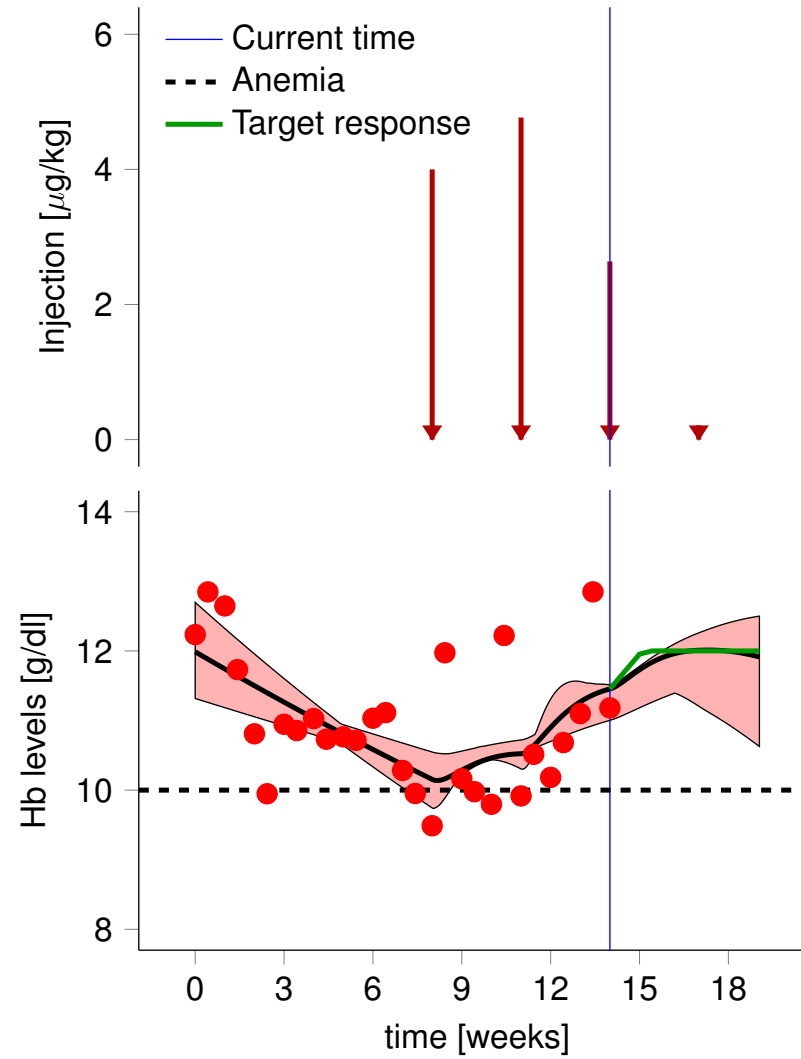

Measurement 30: treatment design

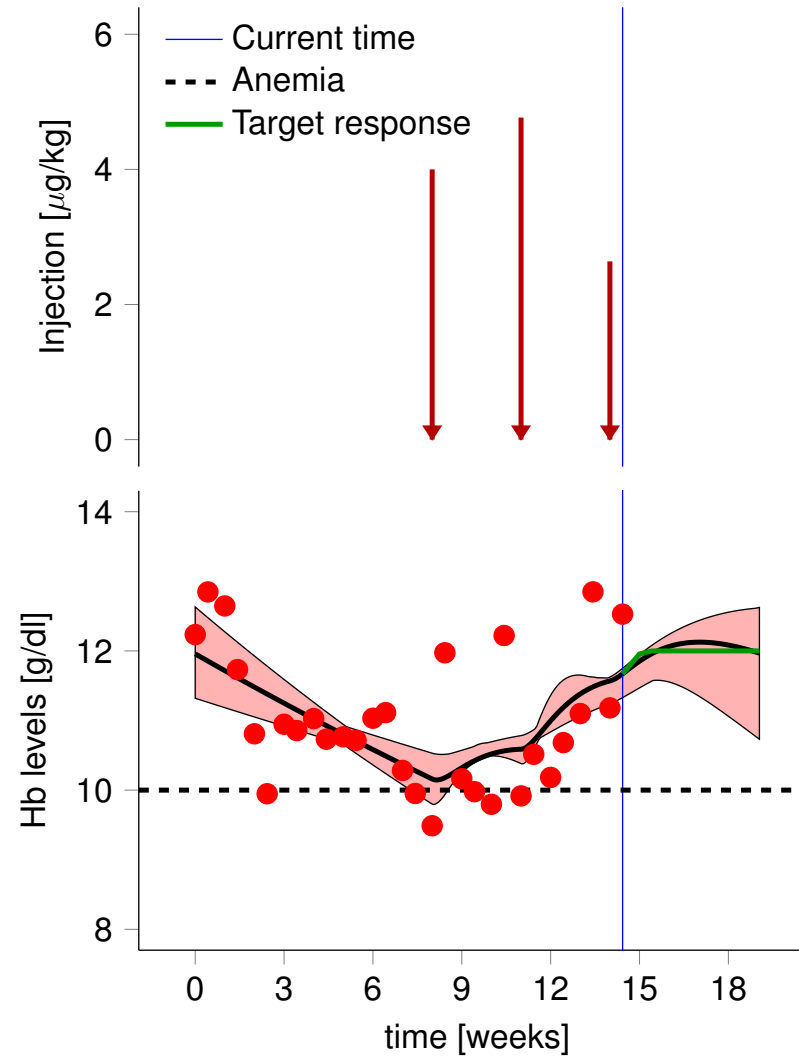

Measurement 31: treatment design

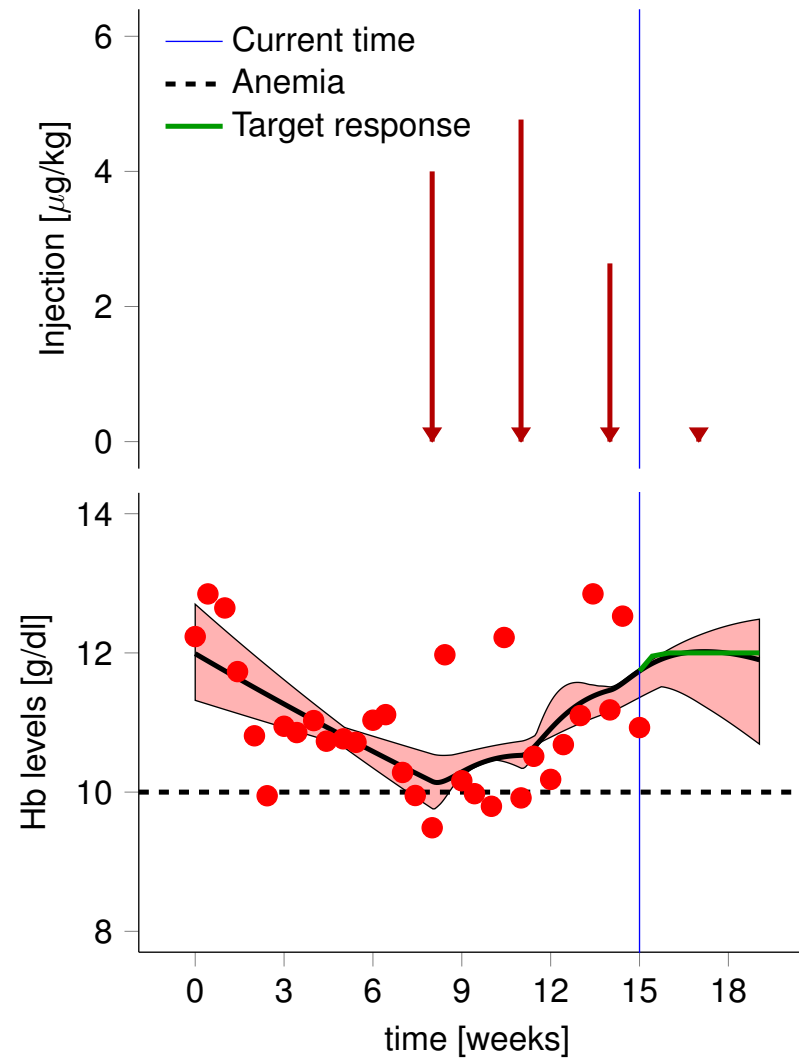

Measurement 32: treatment design

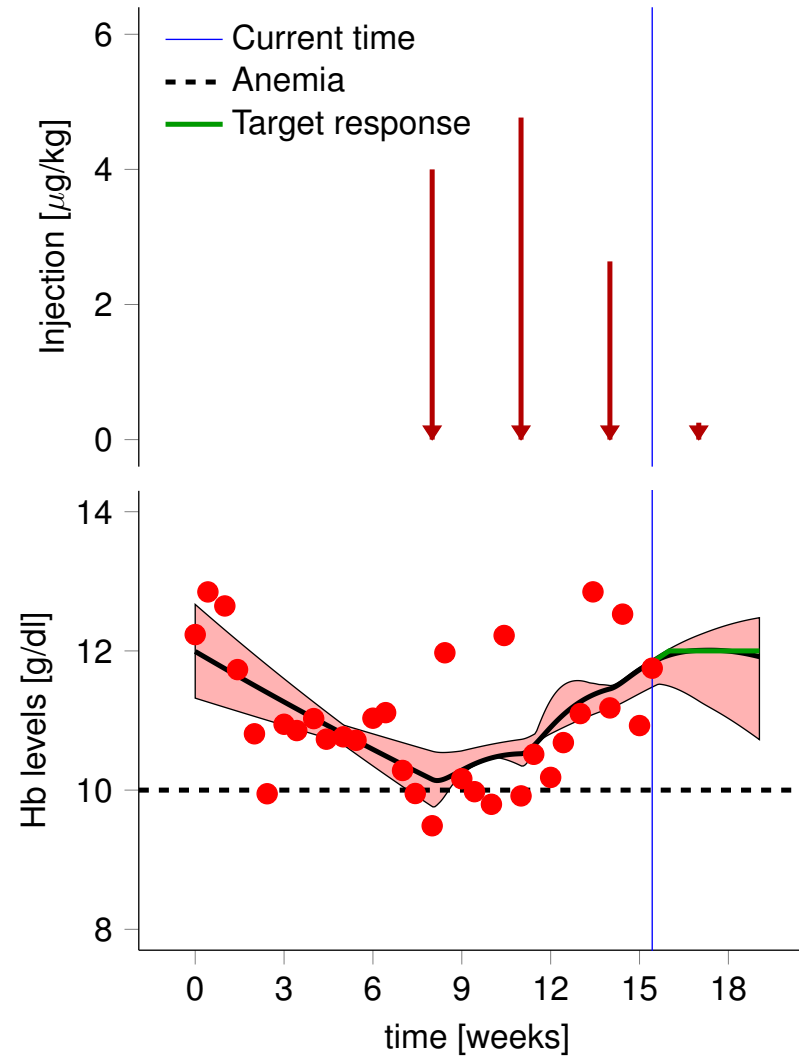

Measurement 33: treatment design

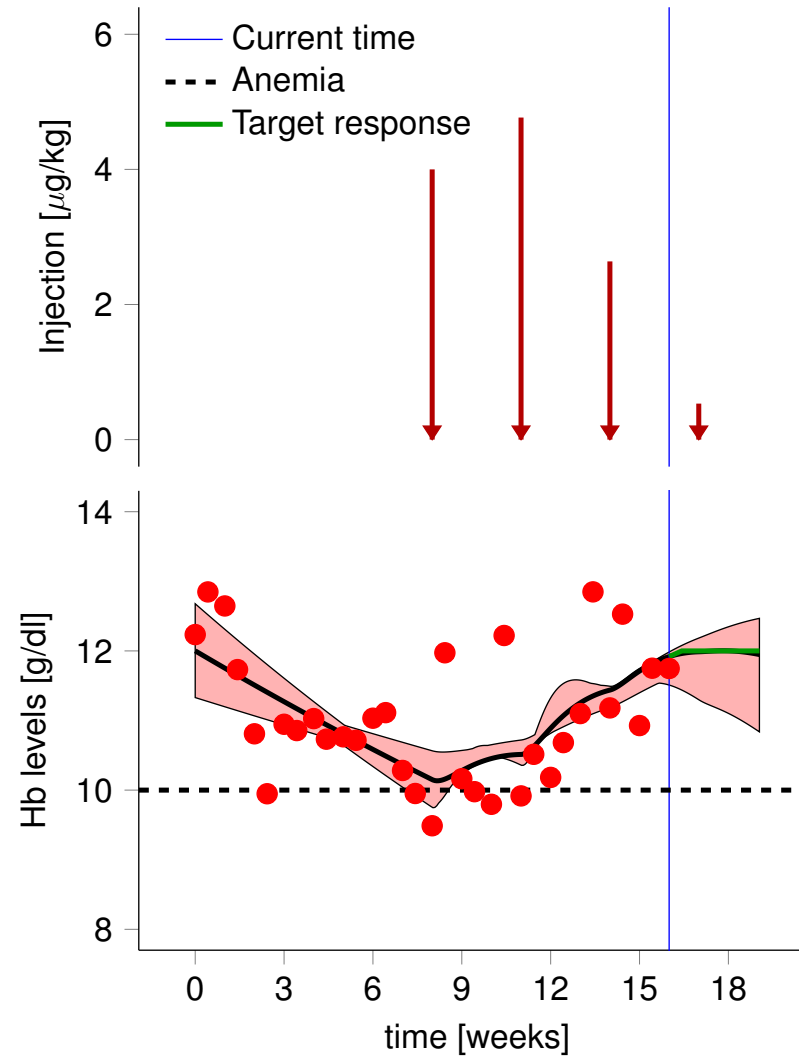

Measurement 34: treatment design

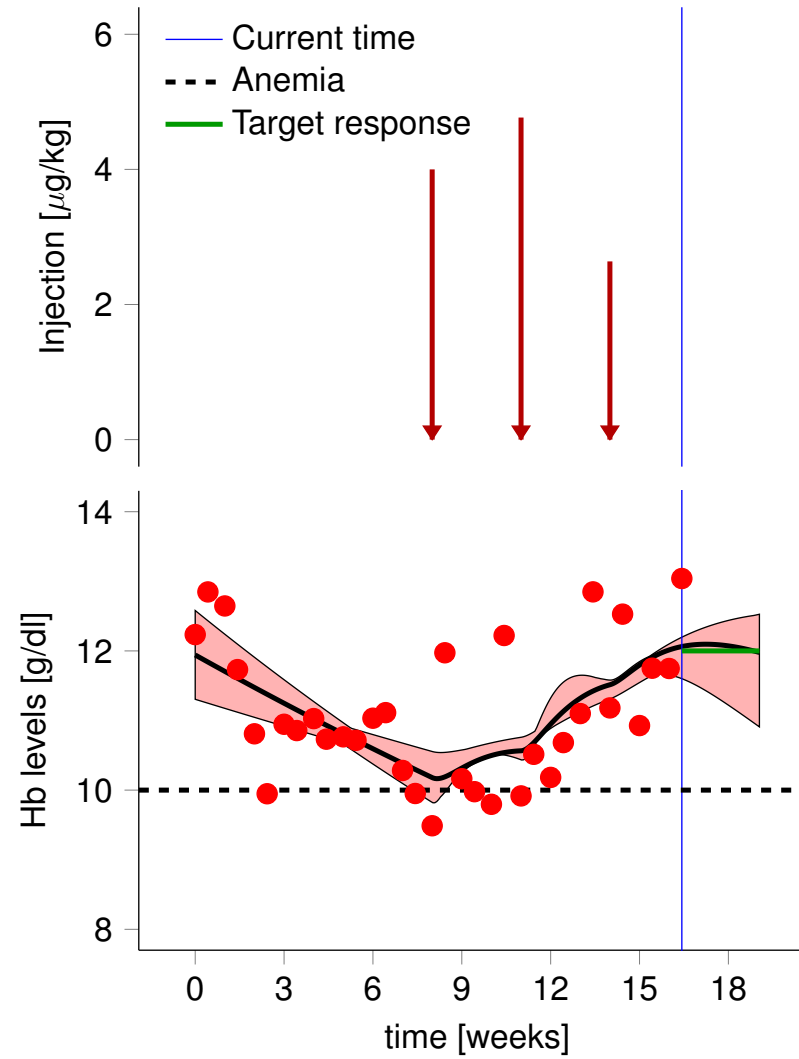

Measurement 35: treatment design

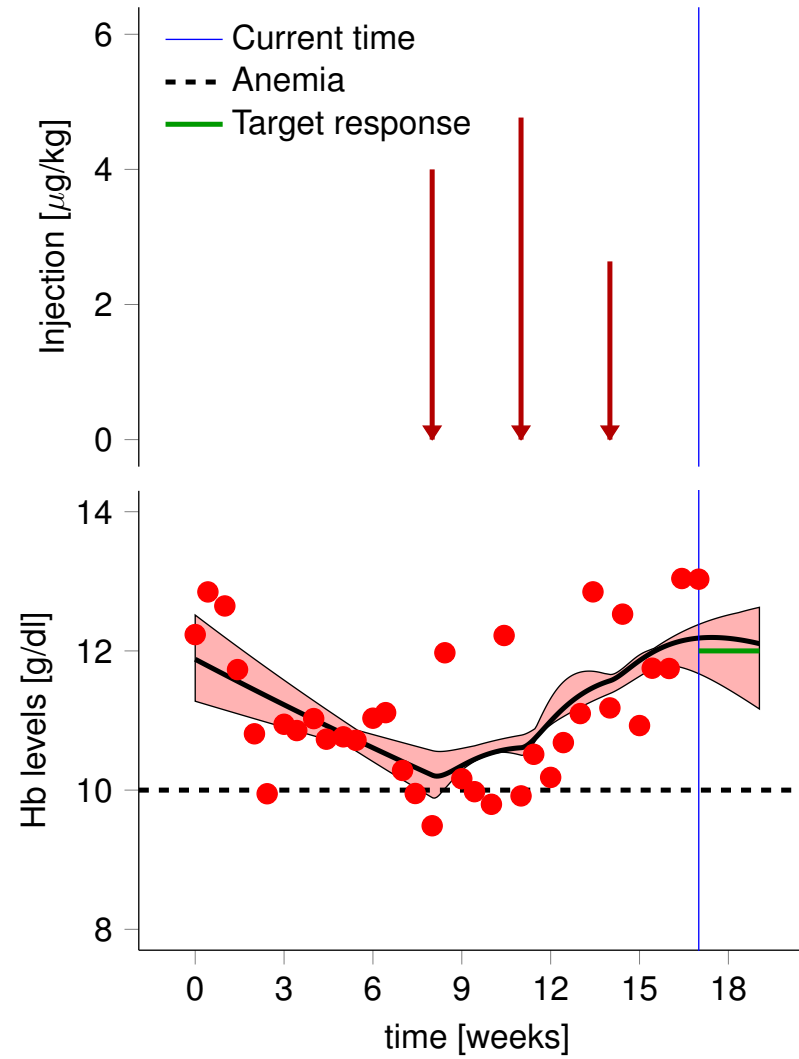

Measurement 36: treatment design

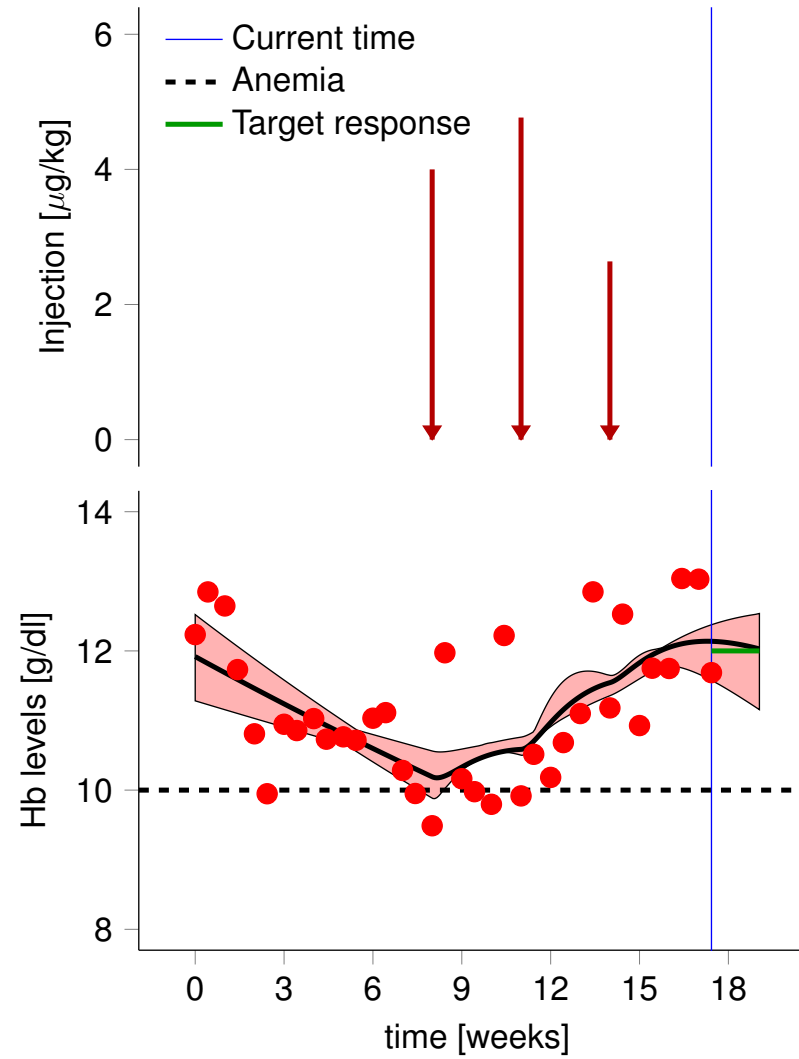

Measurement 37: anemia cured

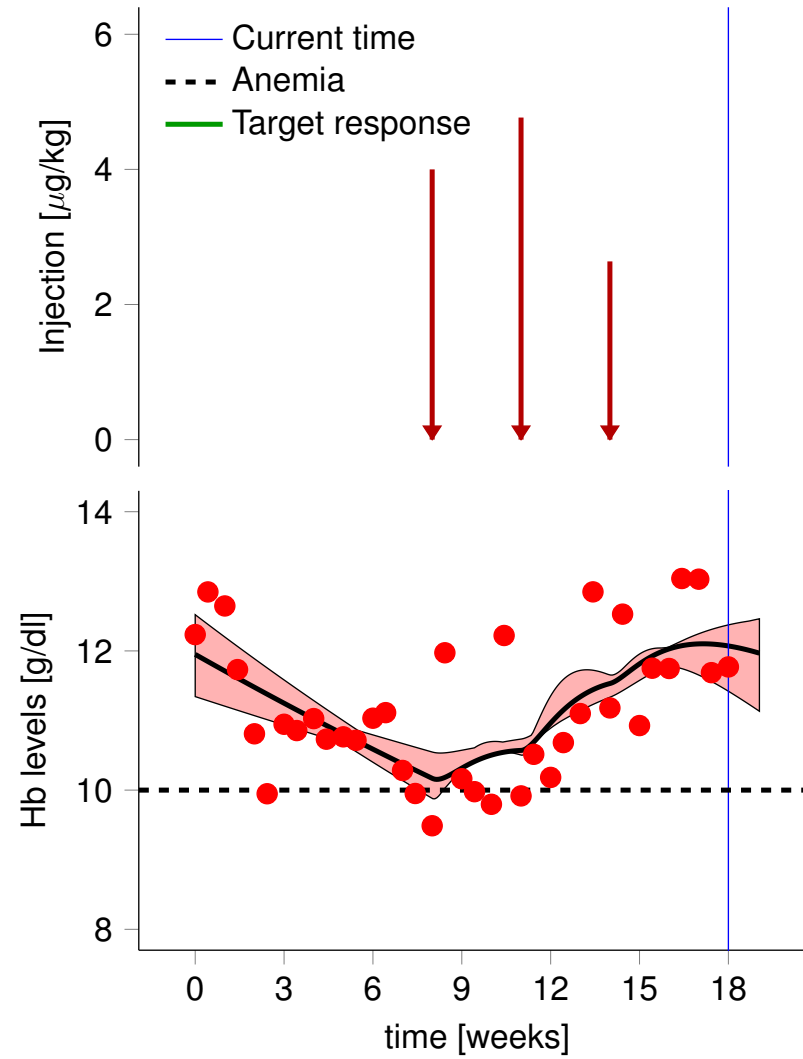

Platform for Physicians

Personalized anemia management

Patient

Thorax 2

- ESA (Aranesp 500)
- Blood transfusion (2 units)
- Chemotherapy

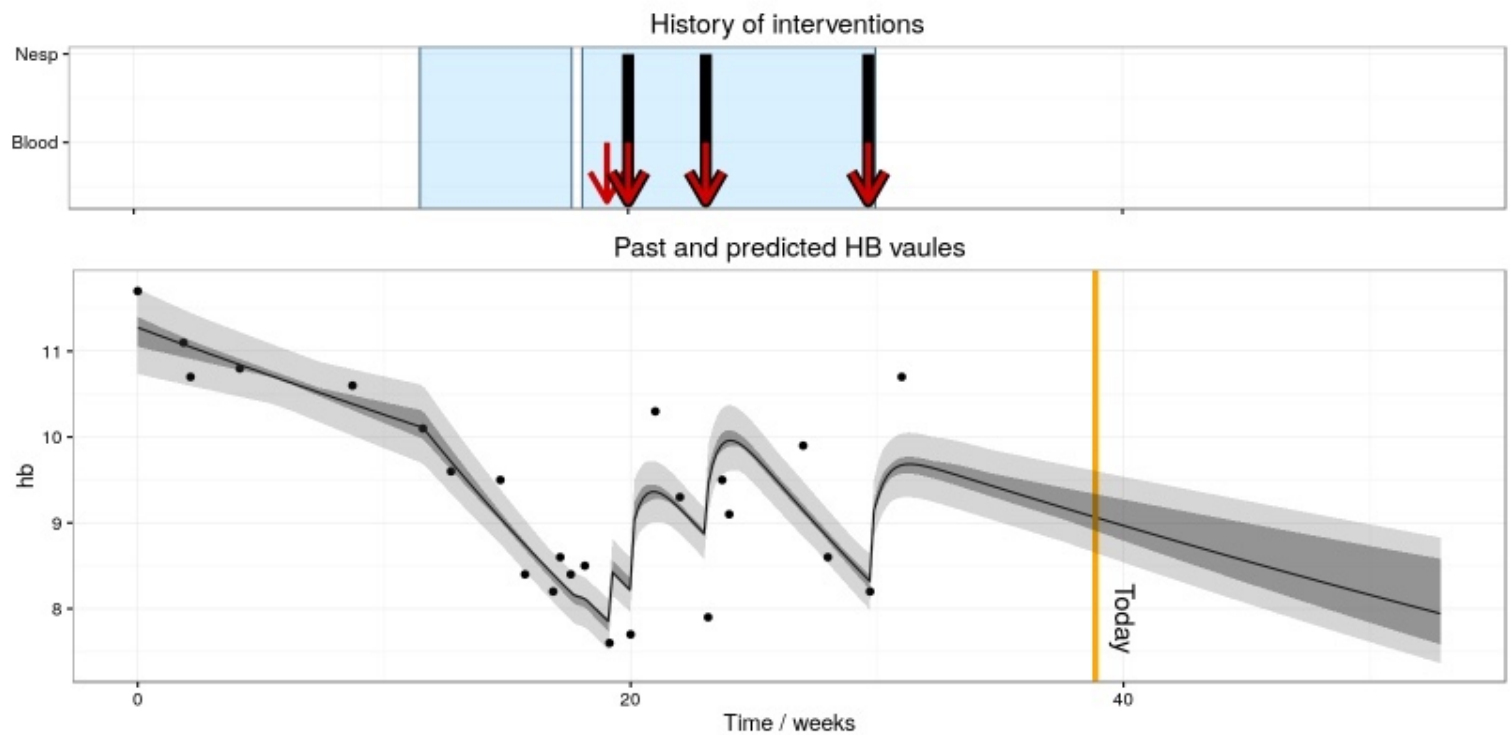

Platform for Physicians

Personalized anemia management

Patient

Thorax 2

ESA (Aranesp 500)

Blood transfusion
(2 units)

Chemotherapy

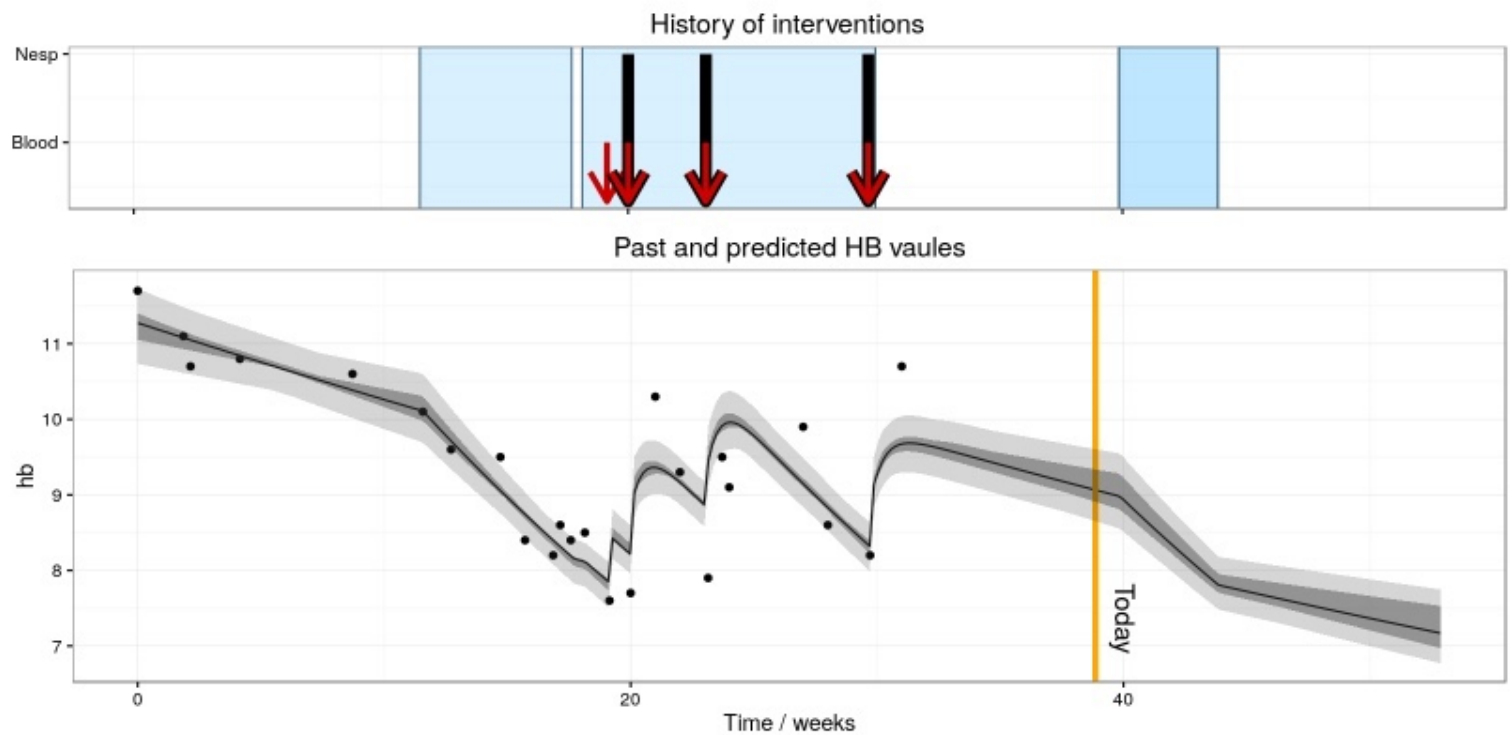

Platform for Physicians

Personalized anemia management

Patient

Thorax 2

ESA (Aranesp 500)

Blood transfusion
(2 units)

Chemotherapy

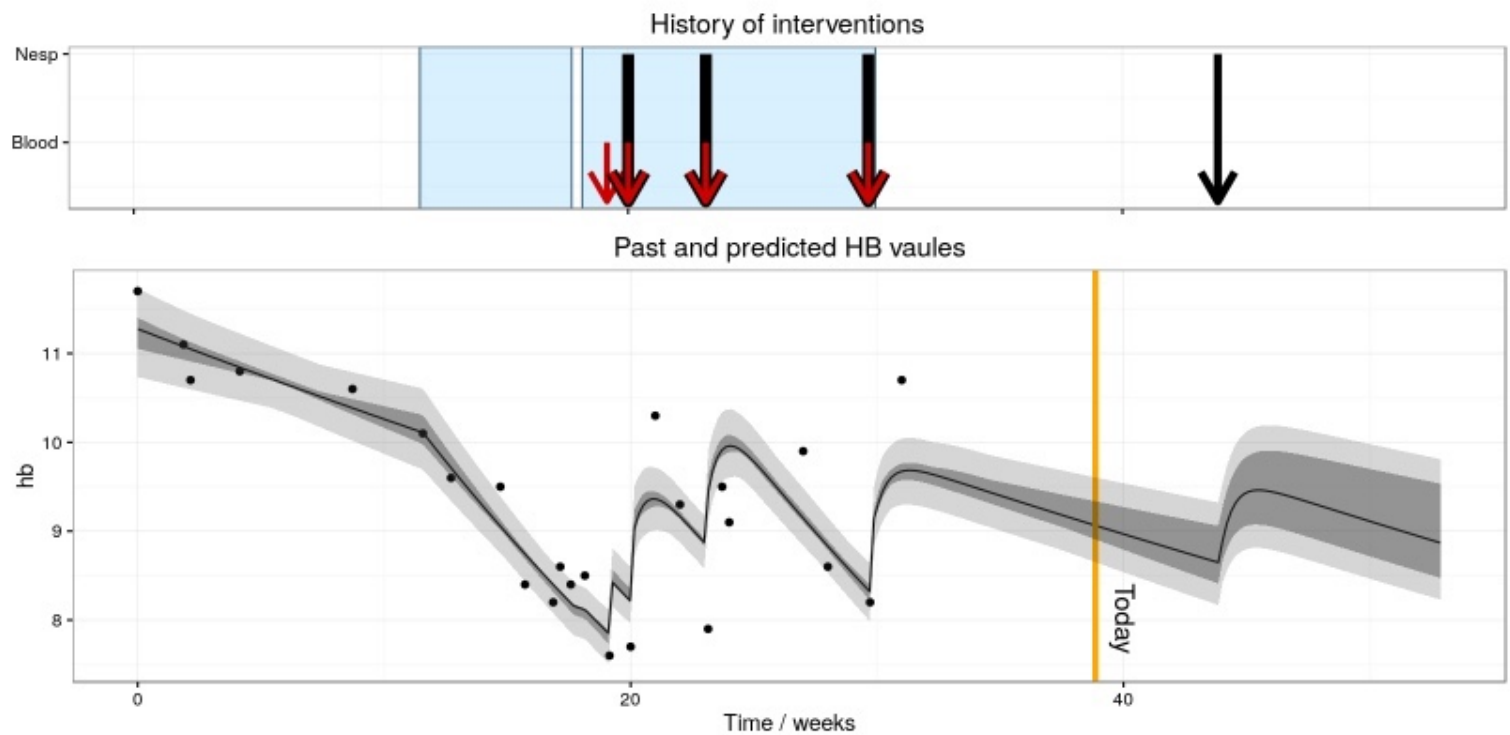

Platform for Physicians

Personalized anemia management

Patient

Thorax 2

ESA (Aranesp 500)

Blood transfusion (2 units)

Chemotherapy

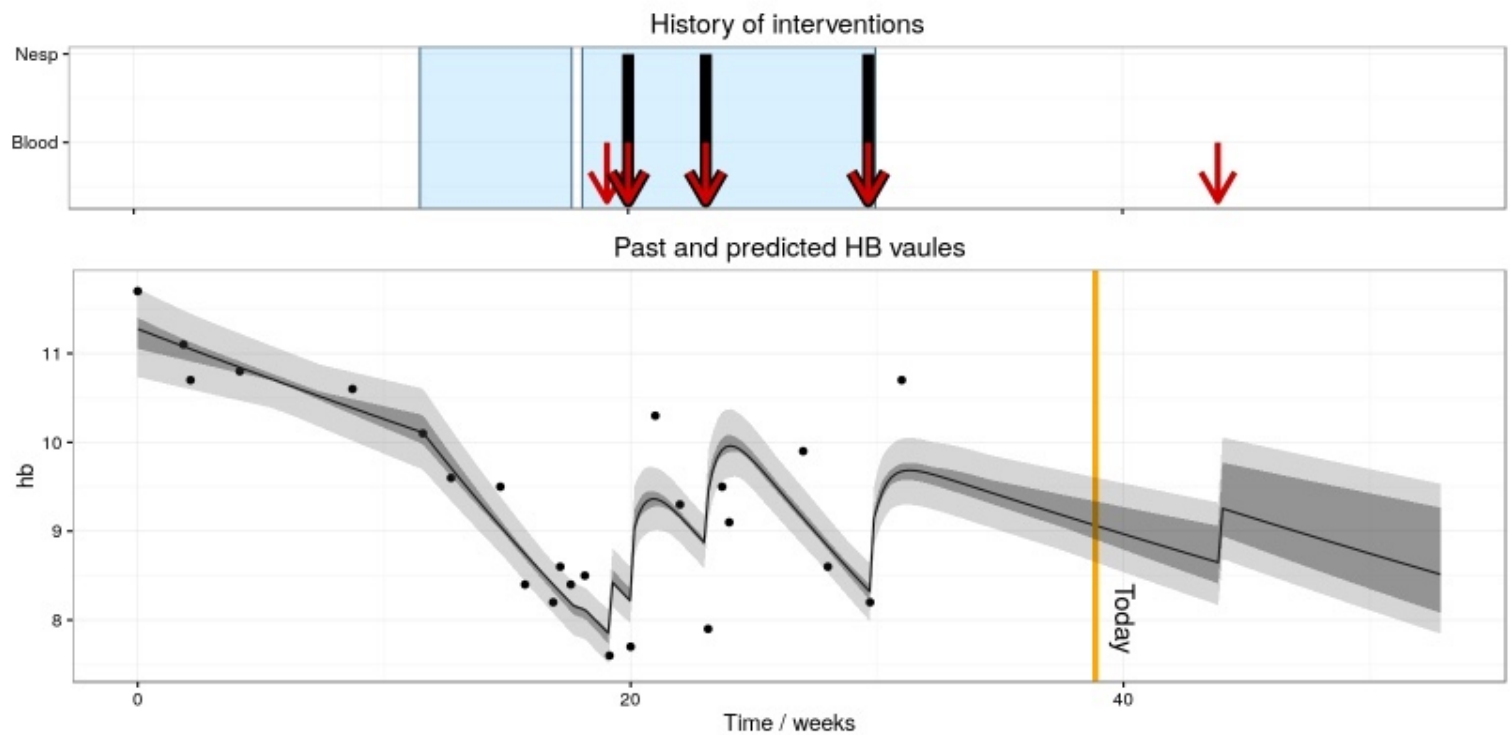

Platform for Physicians

Personalized anemia management

Patient

Thorax 2

ESA (Aranesp 500)

Blood transfusion
(2 units)

Chemotherapy

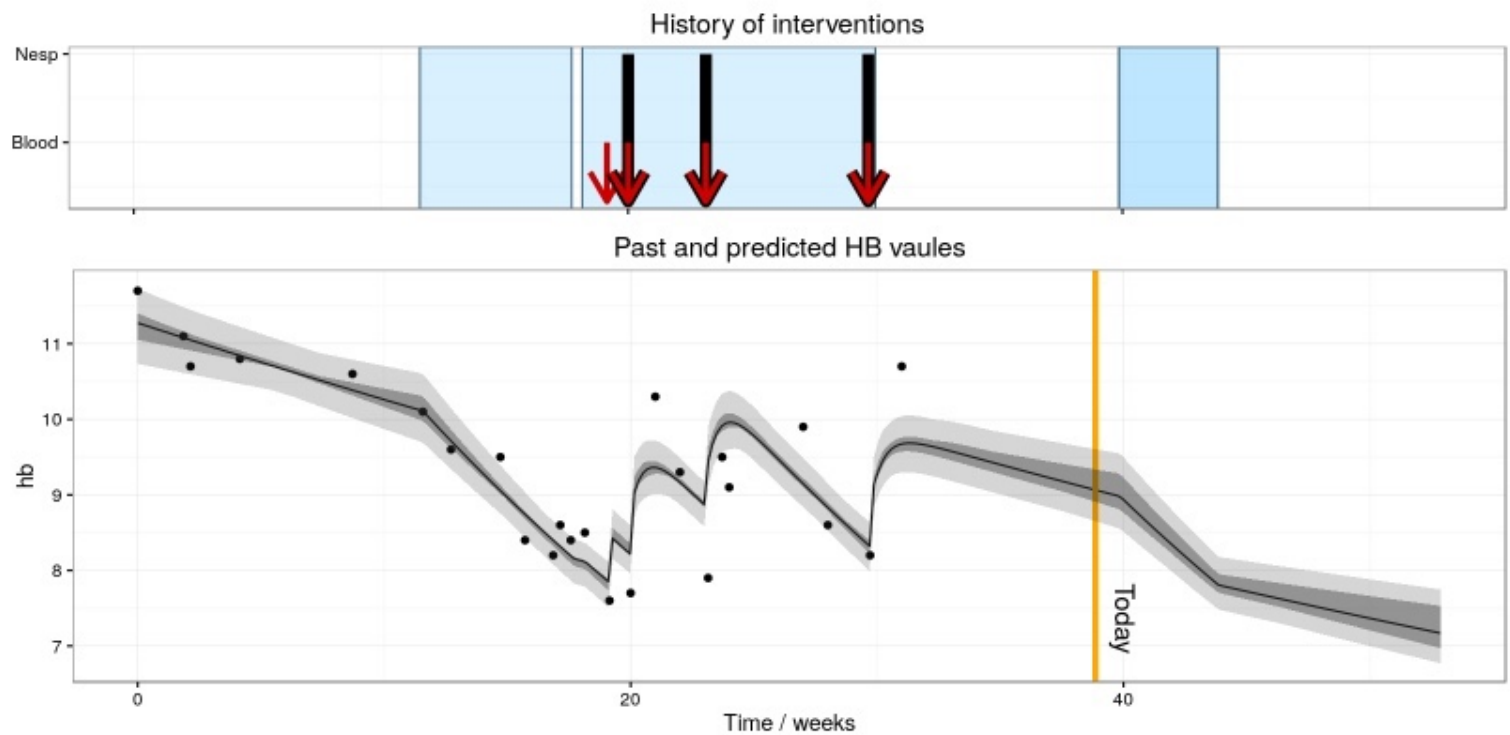

Platform for Physicians

Personalized anemia management

Patient

Thorax 2

ESA (Aranesp 500)

Blood transfusion
(2 units)

Chemotherapy

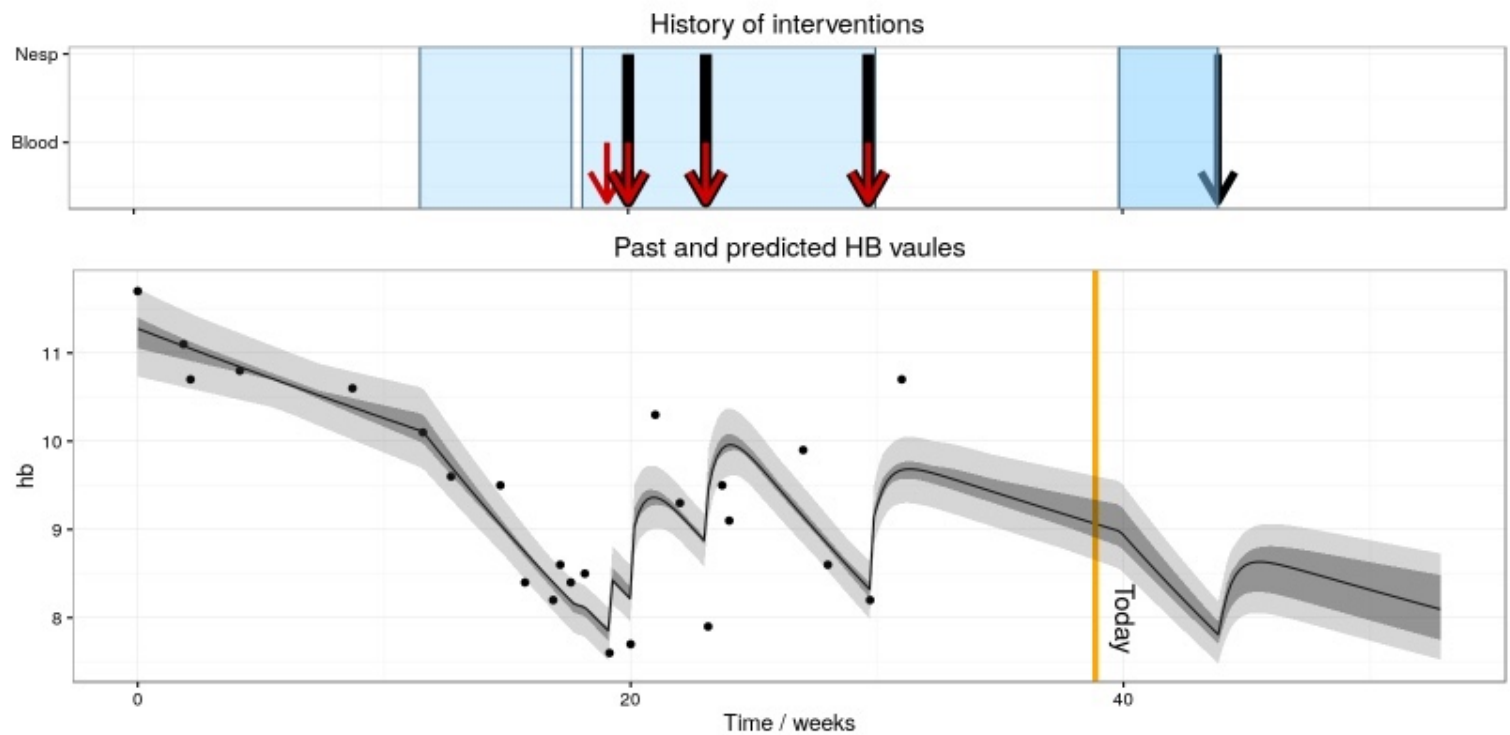

Platform for Physicians

Personalized anemia management

Patient

Thorax 2

- ESA (Aranesp 500)
- Blood transfusion (2 units)
- Chemotherapy

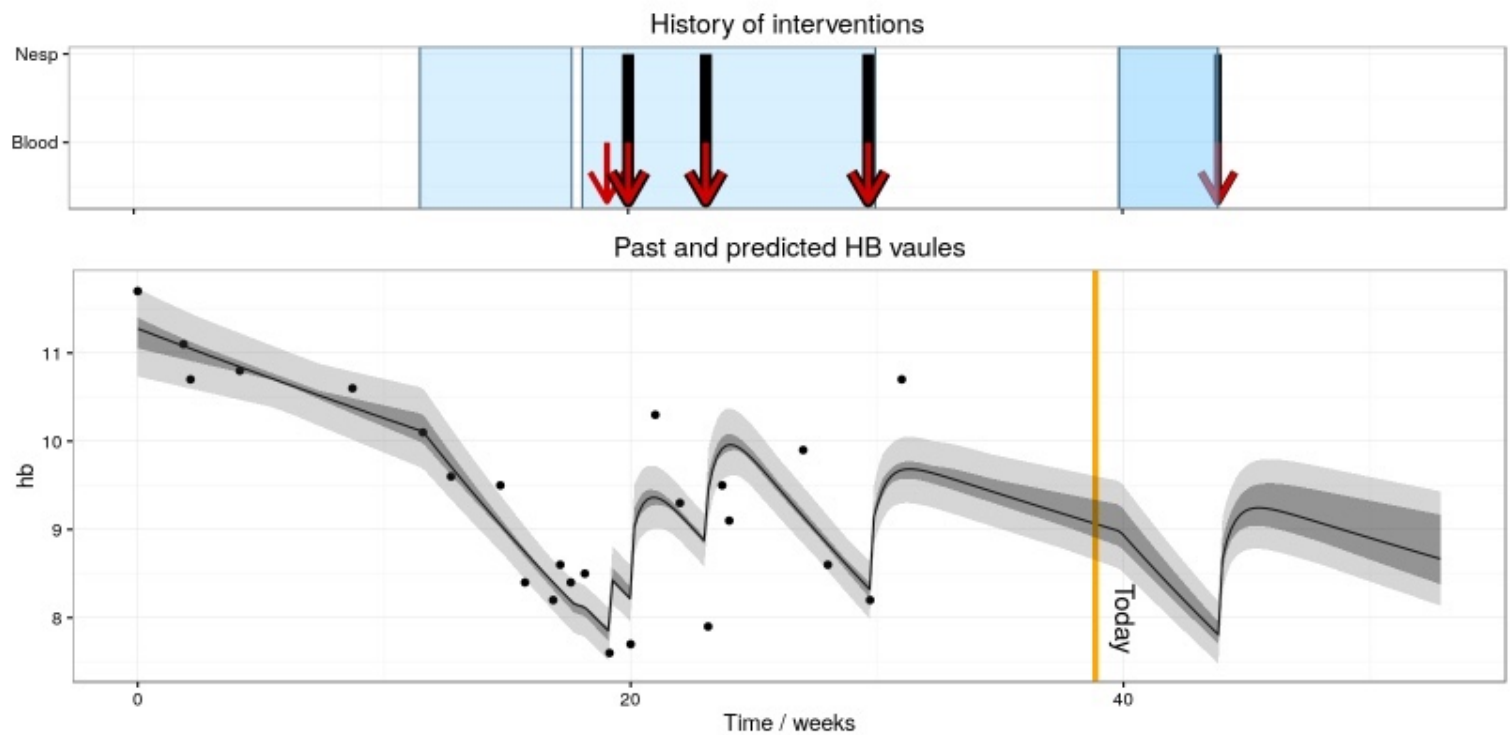

Acknowledgments

German Cancer Research Center

Agustin Rodriguez

Marcel Schilling

Martin Böhm

Florian Salopiata

Sofia Depner

Ruth Merkle

Bernhard Kramer

Markus Stepath

Susen Lattermann

Marvin Wäsch

Lorenz Adlung

Marie-Christine Wagner

Ursula Klingmüller

Wolf D. Lehmann

University Hospital Heidelberg

Anthony Ho

Patrick Wuchter

University of Freiburg

Lukas Refisch

Max Schelker

Andreas Raue

Bernhard Steiert

Roche

Michael Jarsch

Andreas Franke

Summary

Information processing through Epo receptor

- **Fast recovery of cell surface EpoR**
- **Rapid Epo depletion**
- **Linear relation of Epo levels and integral EpoR activation over a broad range of ligand concentrations**
- **Accurate translation of ligand input into erythrocyte production**

Becker, V., Schilling, M., Bachmann, J., Baumann, U., Raue, A., et al. (2010). Covering a broad dynamic range: information processing at the erythropoietin receptor. *Science* 328 (5984), 1404-1408.

Medical perspective

- **Stratification of patients**
- **Individualized optimal treatment of anemia**

If you are interested in joining the group, send me e-mail